

NEW 2020/21
EDITION

Quality is Our Policy

SPACE

Space Display UK Limited



Premium Quality Portable Display Solutions

About Us...

Space Display is an internationally recognised player in the portable display industry

We specialise in manufacturing user friendly, portable display and presentation systems

Our primary aim is to provide premium quality, stylishly designed products at affordable prices

We firmly believe the key to our success is our dedication to quality, service and innovation

Whatever your portable display requirements, we have the best solution

Stand out from the crowd with Space Display!

Our Product Range ...



Pages 3-4 EDGE Pop Up System, Light Boxes & Counter **New**



Pages 5-7 NEO Pop-Up System



Page 08-22 NEO Self-Build Exhibition & Event Stands - **NEW**



Page 23 MESA Pop Up Counter



Page 24 MESA Pop Up Tower Counter

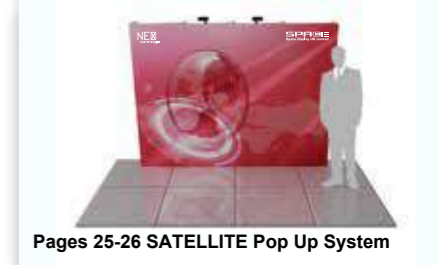

Pages 25-26 SATELLITE Pop Up System

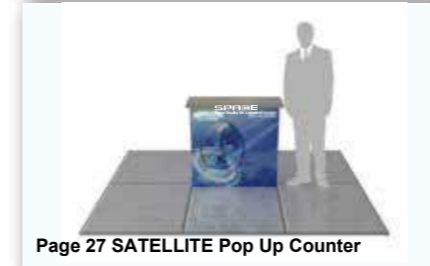

Page 27 SATELLITE Pop Up Counter



Page 28 ZING Literature Rack



Pages 29-30 TECHNO iPad Stands



Pages 31-32 LINK Roller Banner



Pages 33-34 SUPREME Roller Banner



Page 35 DUAL Roller Banner



Page 36 MINI Roller Banner



Page 37 SCROLL MC Roller Banner



Page 38 FINESSE Roller Banner



Page 39 AXIS Roller Banner



Page 40 RACE Roller Banner



Page 41 DASH Roller Banner



Page 42 LITE Tensioned Banner Wall



Page 43 MAGNETIC BANNER LOCKS



Page 44 SPYDER X-Banner - **NEW**



EDGE Pop Up System (Silicone Edge Graphics) **NEW**

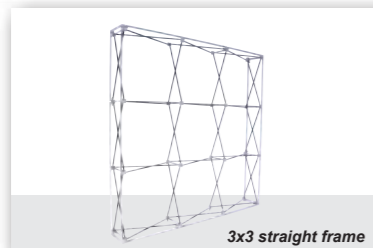
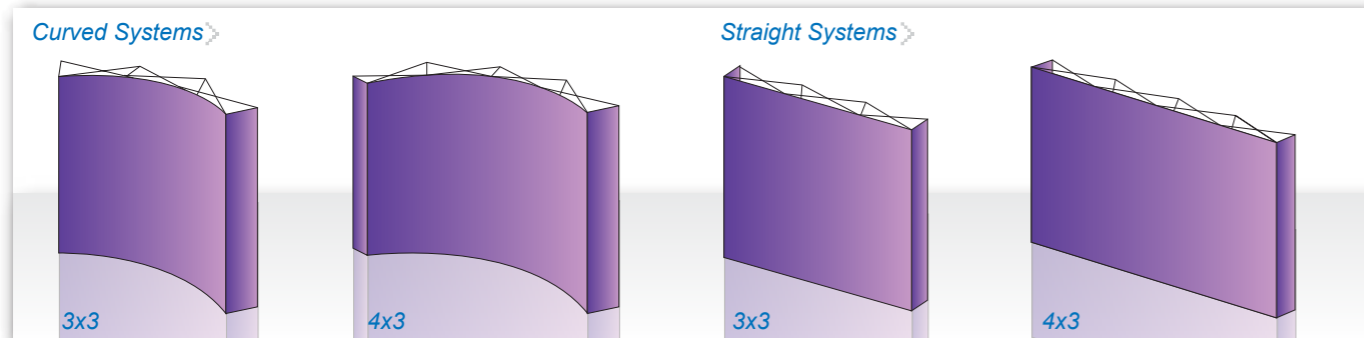
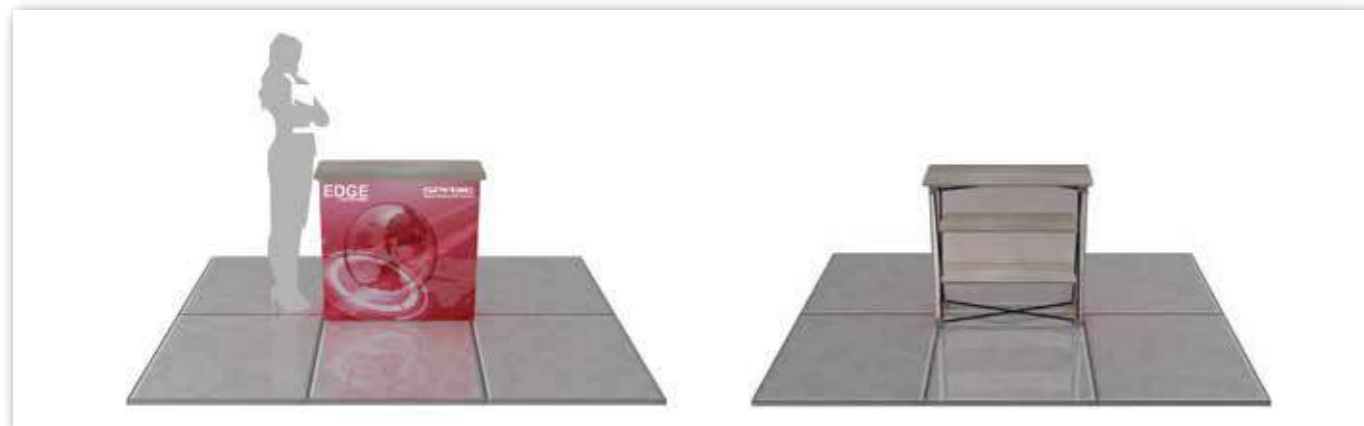

- ❖ An elegant range of next generation, flat pack, tension fabric pop up displays, designed to hold Silicone Edge Graphics (SEG) and offer a sleek seamless presentation
- ❖ System can be assembled in about 10 minutes, simply expand the frame into position on the floor, attach the hinged channel bar sets, then gently push fit the silicone strip on the perimeter of the graphic, into the slots on the channel bars
- ❖ The strong, yet lightweight aluminium frames offer excellent structural stability and they are less than half the weight of traditional magnetic pop up systems too

EDGE Pop-Up LIGHT BOXES (Silicone Edge Graphic) **NEW**

AVAILABLE MID 2020 – Please Contact Us For Further Updates

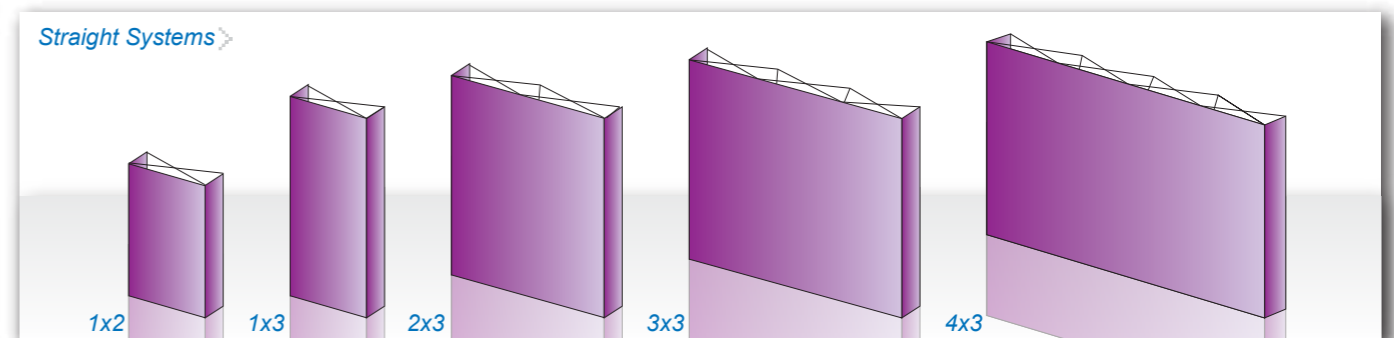

- ❖ Systems are available in 3x3 and 4x3 curved or straight frames and are supplied in a semi rigid wheeled carry bag. Options include halogen or LED flood lights
- ❖ The range also includes five stunning Light Box options in 1x2, 1x3, 2x3, 3x3 and 4x3 straight frame styles. These systems include LED Rear Lighting Kits and a semi rigid wheeled carry bag
- ❖ The final item in this range is an ultra-lightweight 1x1 pop up counter with a wooden top and an internal shelf. This compact and highly portable system is also supplied in a padded carry bag

NEO Magnetic Pop-Up System Bundles



NEO Magnetic Pop-Up System Bundles

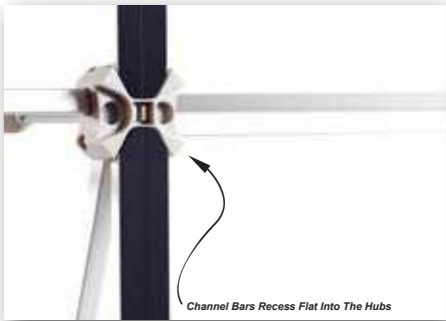
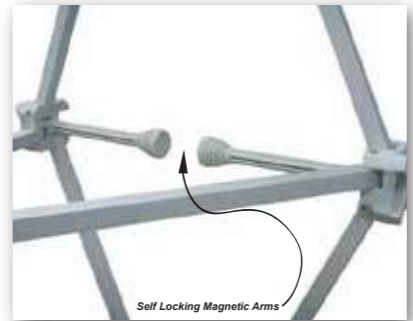
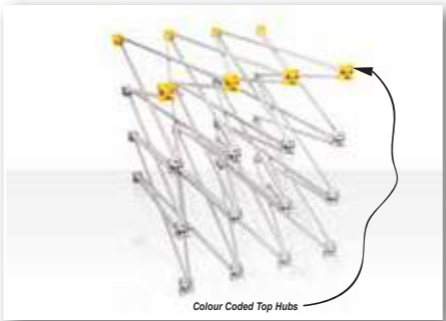

- ❖ Fantastic range of fully magnetic, lightweight and strong pop up display systems with frames manufactured from a silver box aluminium tubing, which offers better structural stability than similar systems made from cylindrical aluminium tubing
- ❖ Features include fully adjustable, twist out feet on the bottom of each floor facing hub, floating magnets on the graphic hangers, offering 360 degree adjustability to achieve perfect graphic alignment and channel bars that neatly recess into the hubs, so graphics also sit perfectly flat

- ❖ Supplied in a tough wheelie bin style transit case, with a folding wooden counter conversion top Includes a pair of powerful 150w flood lights which are stored in a foam lined compartment inside the transit case lid
- ❖ An extremely compact and highly portable solution for any kind of display requirement

NEO Magnetic Pop-Up System Bundles

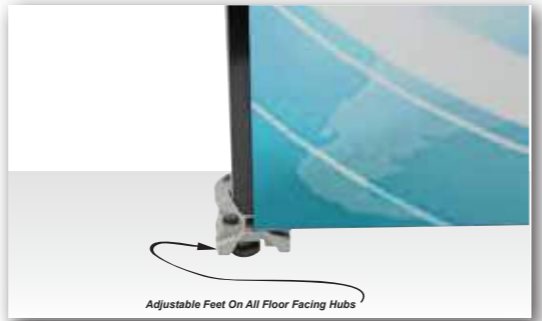
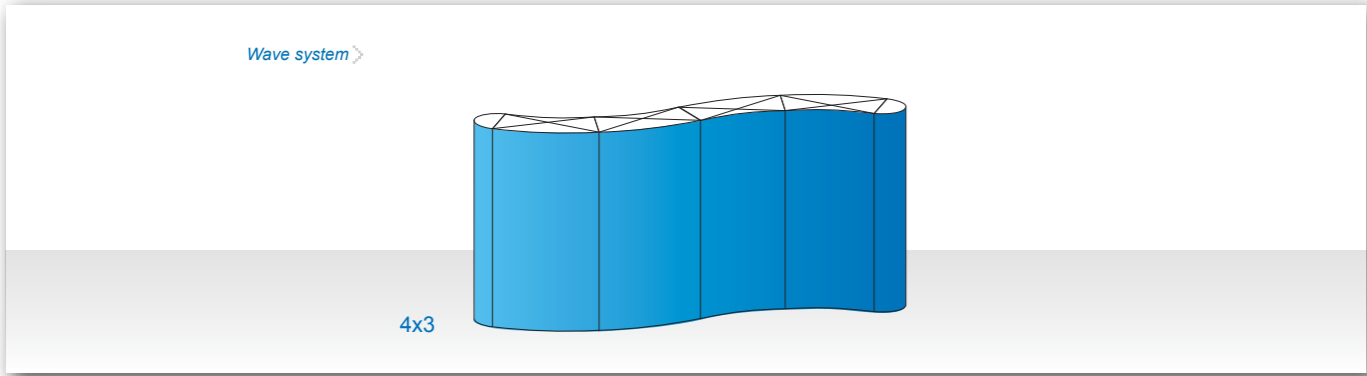

- ❖ Simply expand the frame and let the magnetic arms gently lock the system into position, then add the magnetic channel bars to the magnetic hubs, attach the graphic panels magnetically to the channel bars and finally mount the floodlights, to create an extremely impressive landscape display
- ❖ Available in curved or straight frame styles in either 2x3, 3x3 or 4x3 configurations and New 4x3 wave configuration

NEO Self-Build Exhibition & Event Stands - **NEW**

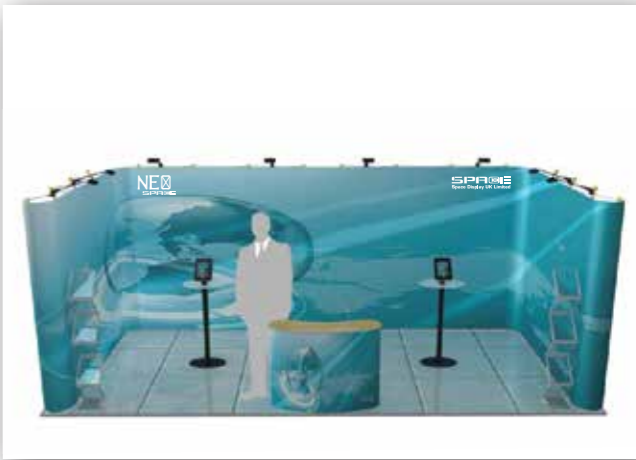
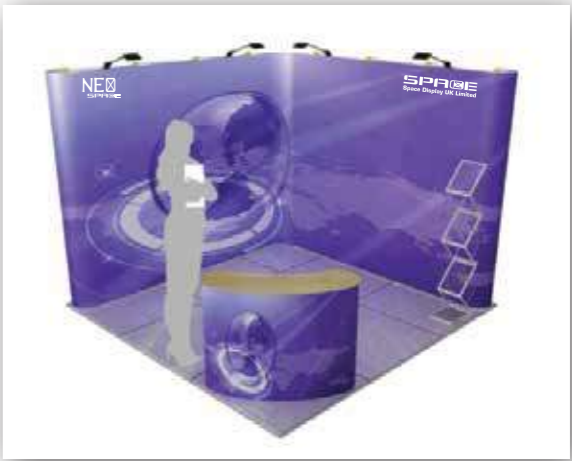
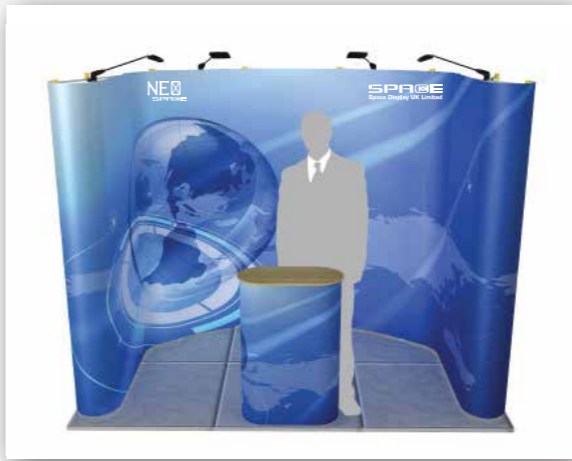

- ❖ A cost effective range of 20 Self-Build Exhibition and Event Stands, constructed from our top selling NEO Pop Up Display Systems, for use in Shell Scheme Booths or any open display areas
- ❖ Wheeled transit cases and flood lights are included as standard with all packages, so this exciting new range of self-build modular display systems offers the perfect cost effective solution, with full re-usability

Self-Build Exhibition Stand - 1A 2m x 3m Area With 3 Walls

Products Required To Create Stand 1A

- ❖ 1 off NEO 3x3 Curved Pop Up Display Bundle
- ❖ 1 off NEO 3x3 Straight Pop Up Display Bundle (To be split into 2 off 1x3 frames)
- ❖ 1 off Rear Button Magnets Kit for 3x3 NEO Frame
- ❖ 1 off MESA 1x3 Curved Pop Up Tower Counter

Self-Build Exhibition Stand - 1C 2m x 3m Area With 2 Walls

Products Required To Create Stand 1C

- ❖ 1 off NEO 2x3 Straight Pop Up Display Bundle
- ❖ 1 off NEO 2x3 Curved Pop Up Display Bundle
- ❖ 1 off MESA 1x3 Curved Pop Up Tower Counter
- ❖ 1 off ZING Literature Rack

Self-Build Exhibition Stand - 1B 2m x 3m Area With 3 Walls

Products Required To Create Stand 1B

- ❖ 1 off NEO 2x3 Straight Pop Up Display Bundle
- ❖ 1 off NEO 3x3 Straight Pop Up Display Bundle (To be split into 2 off 1x3 frames)
- ❖ 1 off Rear Button Magnets Kit for 3x3 NEO Frame
- ❖ 1 off MESA 1x3 Curved Pop Up Tower Counter
- ❖ 2 off ZING Literature Rack

Self-Build Exhibition Stand - 1D 2m x 3m Area With 2 Walls

Products Required To Create Stand 1D

- ❖ 1 off NEO 3x3 Straight Pop Up Display Bundle
- ❖ 1 off NEO 2x3 Straight Pop Up Display Bundle
- ❖ 1 off MESA 2x2 Curved Pop Up Counter
- ❖ 1 off ZING Literature Rack

Self-Build Exhibition Stand - 2A 3m x 3m Area With 3 Walls

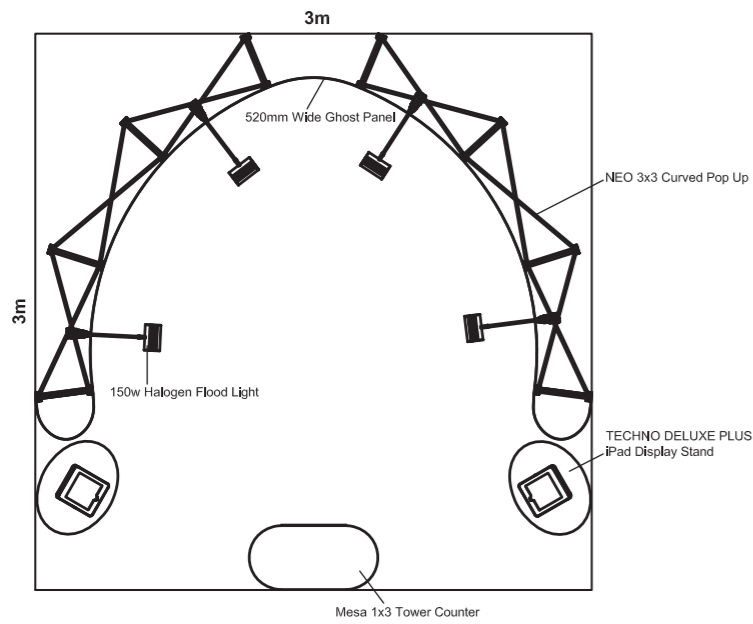

Products Required To Create Stand 2A

- ❖ 2 off NEO 3x3 Curved Pop Up Display Bundles
- ❖ 1 off MESA 1x3 Curved Pop Up Tower Counter
- ❖ 2 off TECHNO Deluxe PLUS iPad Stands



Self-Build Exhibition Stand - 2C 3m x 3m Area With 2 Walls

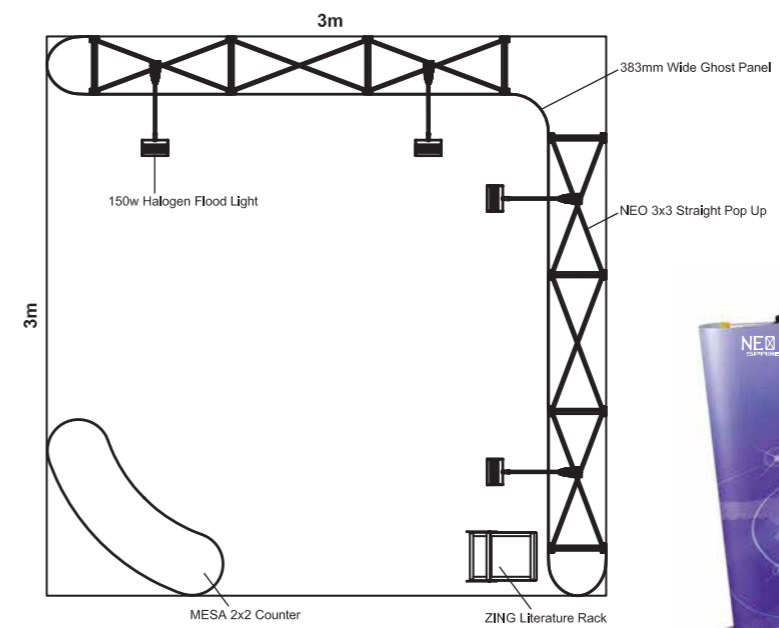

Products Required To Create Stand 2C

- ❖ 2 off NEO 3x3 Straight Pop Up Display Bundles
- ❖ 1 off MESA 2x2 Curved Pop Up Counter
- ❖ 1 off ZING Literature Rack



Self-Build Exhibition Stand - 2B 3m x 3m Area With 3 Walls

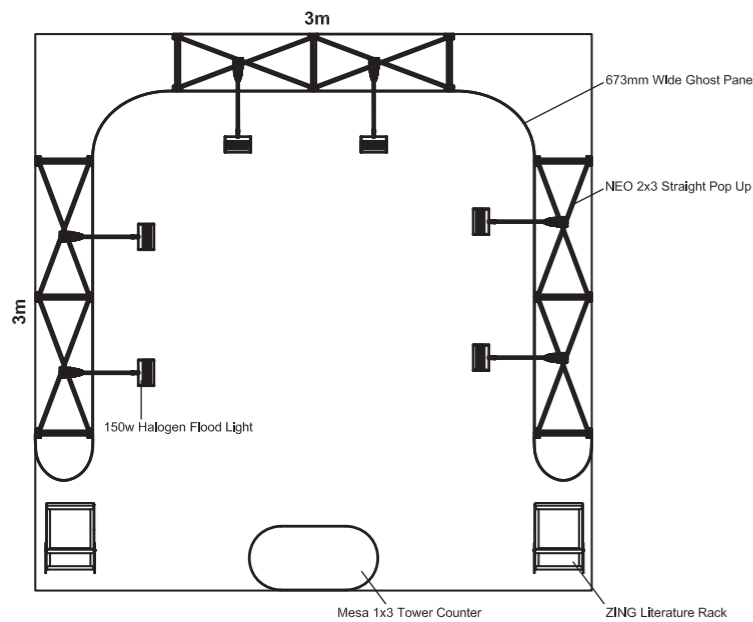

Products Required To Create Stand 2B

- ❖ 3 off NEO 2x3 Straight Pop Up Display Bundles
- ❖ 1 off MESA 1x3 Curved Pop Up Tower Counter
- ❖ 2 off ZING Literature Racks



Self-Build Exhibition Stand - 2D 3m x 3m Area With 2 Walls

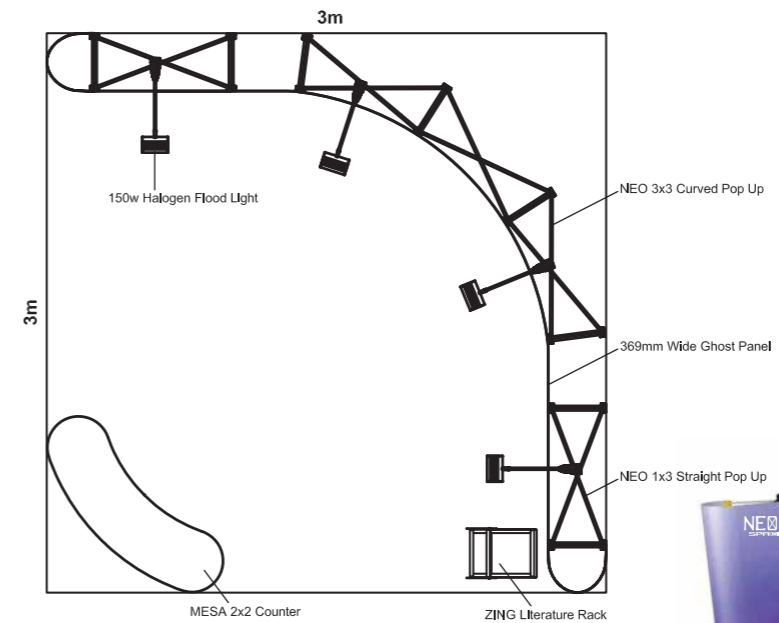

Products Required To Create Stand 2D

- ❖ 1 off NEO 3x3 Curved Pop Up Display Bundle
- ❖ 1 off NEO 3x3 Straight Pop Up Display Bundle (To be split into 2 off 1x3 frames)
- ❖ 1 off Rear Button Magnets Kit for 3x3 NEO Frame
- ❖ 1 off MESA 2x2 Curved Pop Up Counter
- ❖ 1 off ZING Literature Rack



Self-Build Exhibition Stand - 3A 4m x 3m Area With 2 Walls

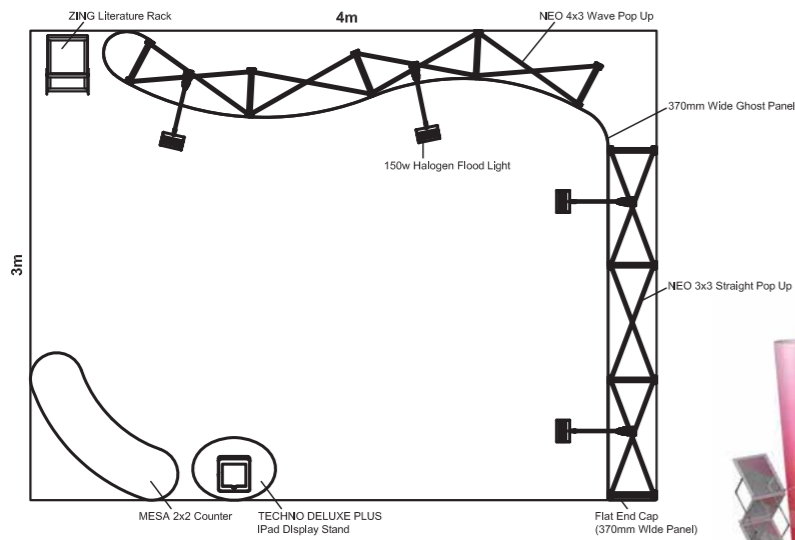

Products Required To Create Stand 3A

- ❖ 1 off NEO 4x3 Wave Pop Up Display Bundle
- ❖ 1 off NEO 3x3 Straight Pop Up Display Bundle
- ❖ 1 off MESA 2x2 Curved Pop Up Counters
- ❖ 1 off TECHNO Deluxe PLUS iPad Stands
- ❖ 1 off ZING Literature Rack

Self-Build Exhibition Stand - 3C 4m x 3m Area With 3 Walls

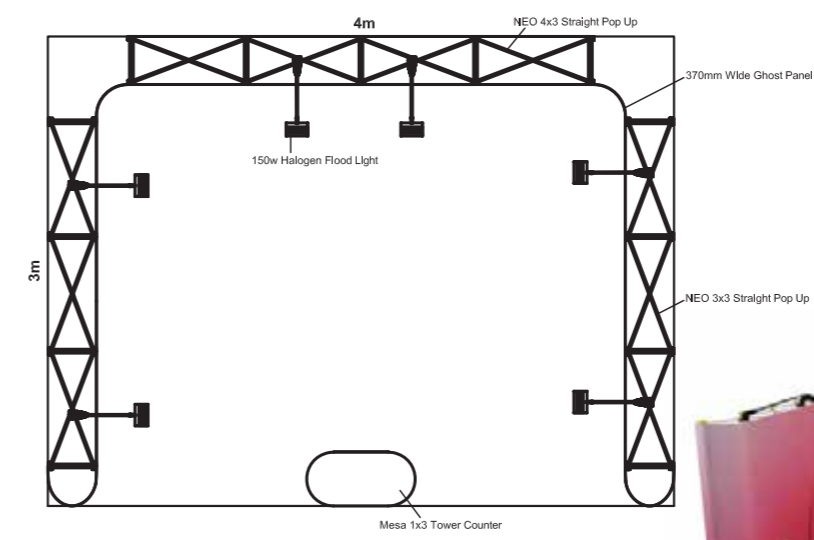

Products Required To Create Stand 3C

- ❖ 2 off NEO 3x3 Straight Pop Up Display Bundles
- ❖ 1 off NEO 4x3 Straight Pop Up Display Bundle
- ❖ 1 off MESA 1x3 Tower Pop Up Counters

Self-Build Exhibition Stand - 3B 4m x 3m Area With 2 Walls

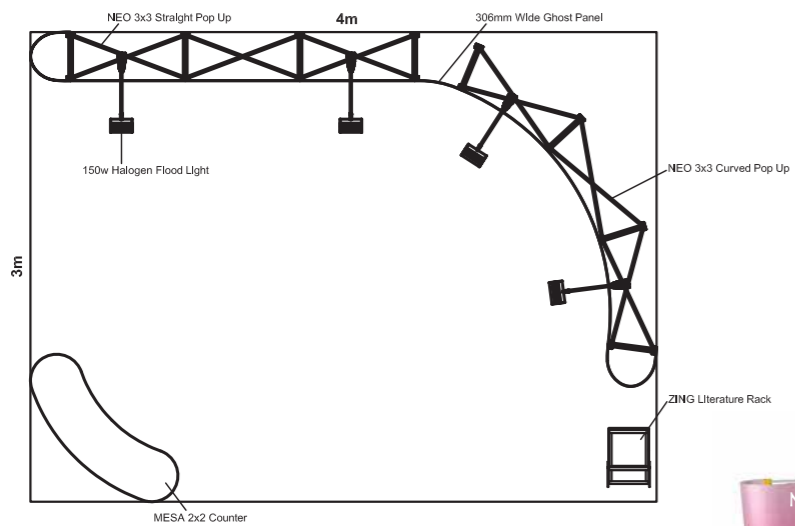

Products Required To Create Stand 3B

- ❖ 1 off NEO 3x3 Curved Pop Up Display Bundle
- ❖ 1 off NEO 3x3 Straight Pop Up Display Bundle
- ❖ 1 off MESA 2x2 Curved Pop Up Counter
- ❖ 1 off ZING Literature Rack

Self-Build Exhibition Stand - 3D 4m x 3m Area With 3 Walls

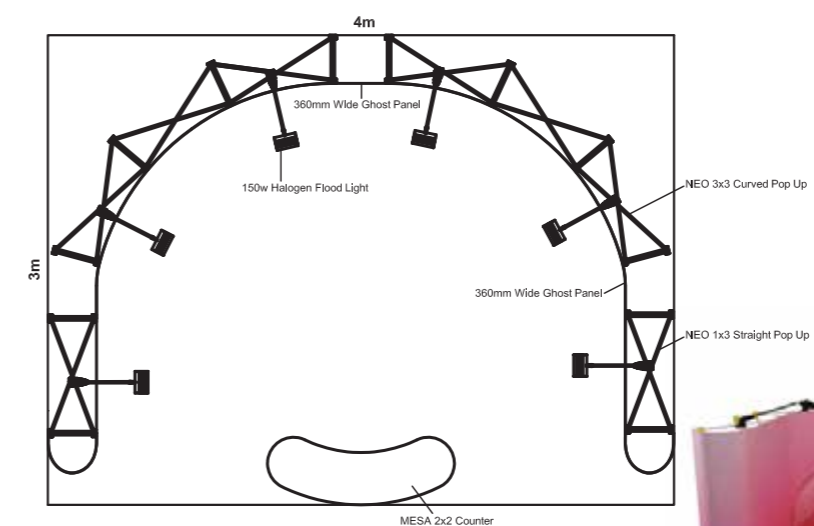

Products Required To Create Stand 3D

- ❖ 2 off NEO 3x3 Curved Pop Up Display Bundles
- ❖ 1 off NEO 3x3 Straight Pop Up Display Bundle (To be split into 2 off 1x3 frames)
- ❖ 1 off MESA 2x2 Curved Pop Up Counter

Self-Build Exhibition Stand - 4C 6m x 3m Area With 2 Walls

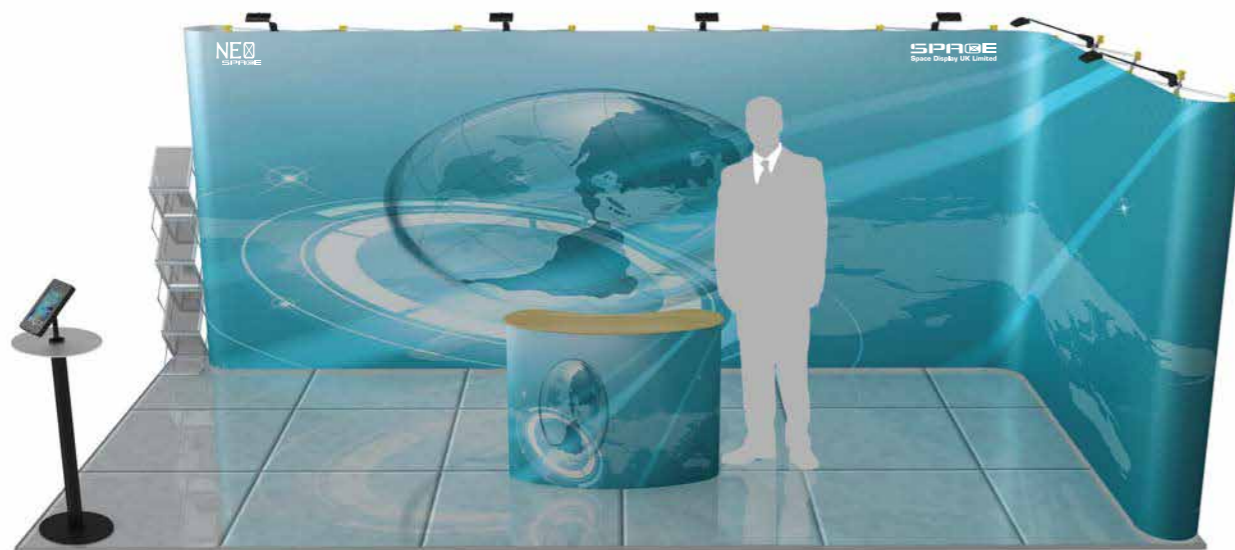
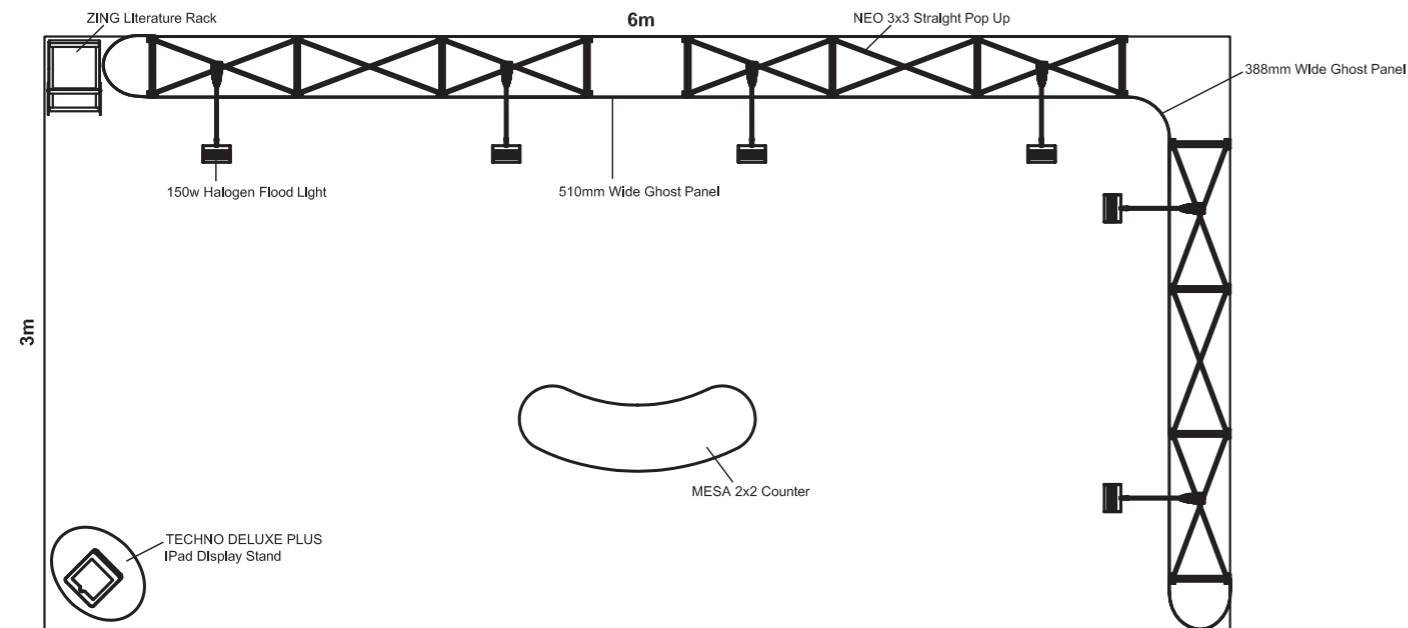

Products Required To Create Stand 4C

- ❖ 3 off NEO 3x3 Straight Pop Up Display Bundles
- ❖ 1 off MESA 2x2 Curved Pop Up Counter
- ❖ 1 off TECHNO Deluxe PLUS iPad Stands
- ❖ 1 off ZING Literature Rack

Self-Build Exhibition Stand - 4D 6m x 3m Area With 2 Walls

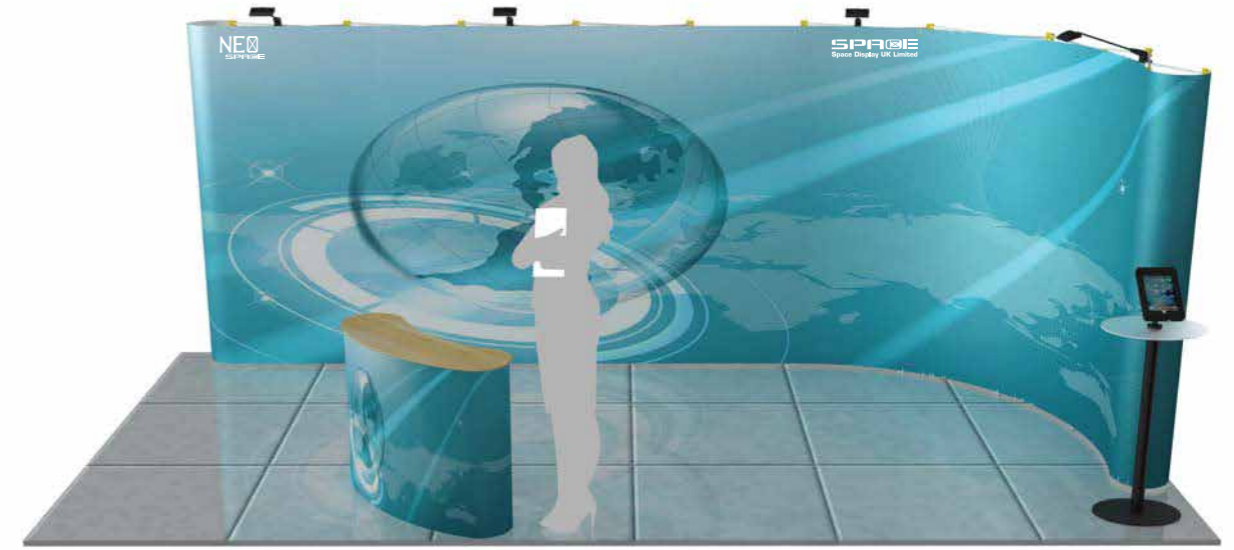
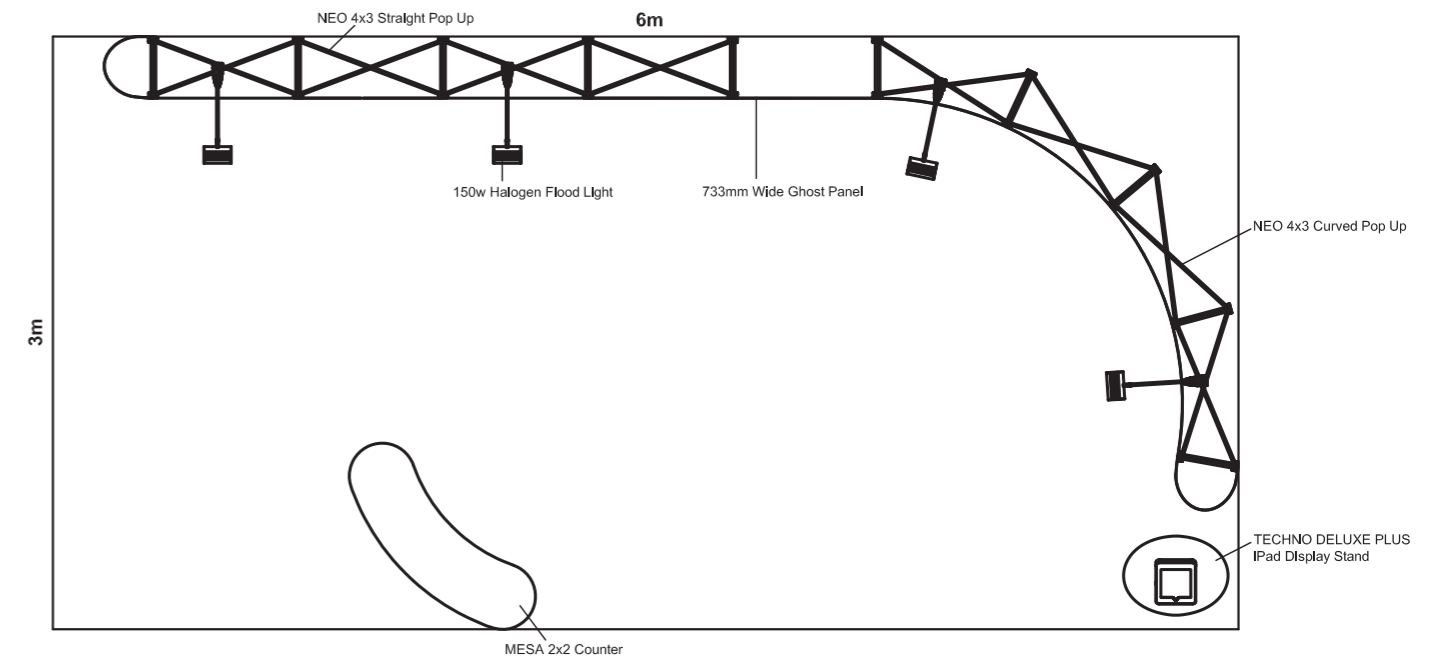

Products Required To Create Stand 4D

- ❖ 1 off NEO 4x3 Straight Pop Up Display Bundle
- ❖ 1 off NEO 4x3 Curved Pop Up Display Bundle
- ❖ 1 off MESA 2x2 Curved Pop Up Counter
- ❖ 1 off TECHNO Deluxe PLUS iPad Stands

Self-Build Exhibition Stand - 4C 6m x 3m Area With 2 Walls

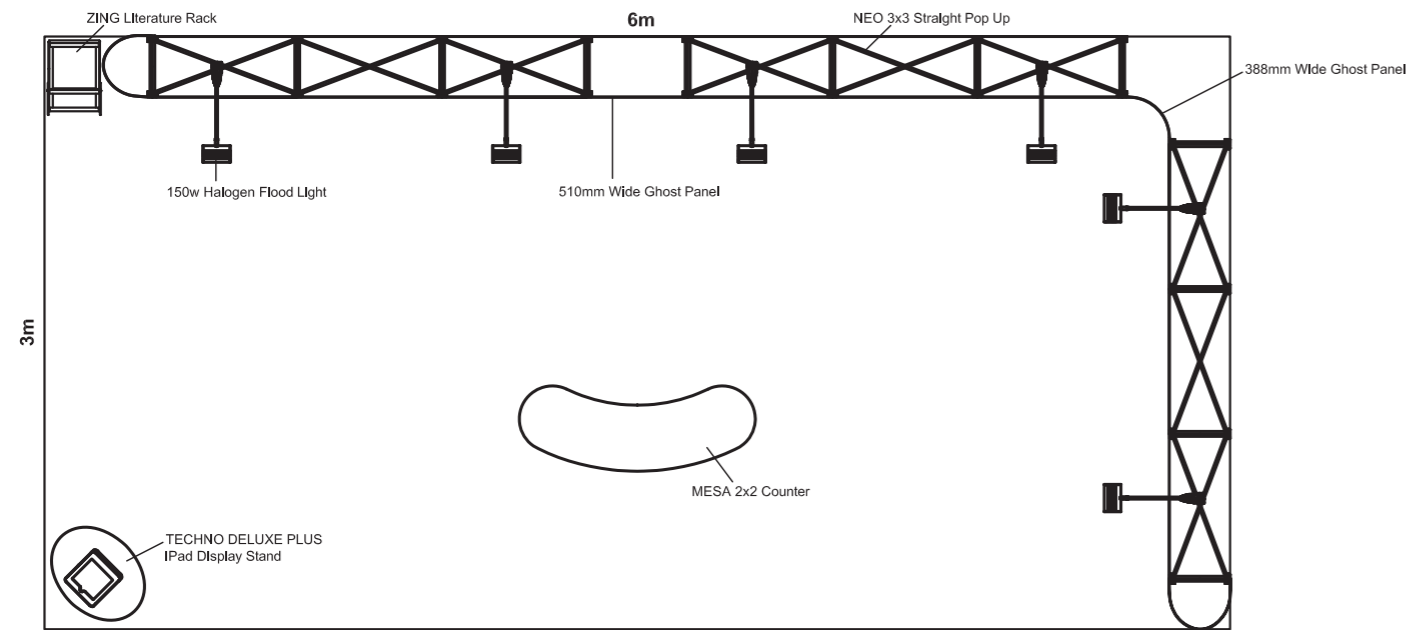

Products Required To Create Stand 4C

- ❖ 3 off NEO 3x3 Straight Pop Up Display Bundles
- ❖ 1 off MESA 2x2 Curved Pop Up Counter
- ❖ 1 off TECHNO Deluxe PLUS iPad Stands
- ❖ 1 off ZING Literature Rack

Self-Build Exhibition Stand - 4D 6m x 3m Area With 2 Walls

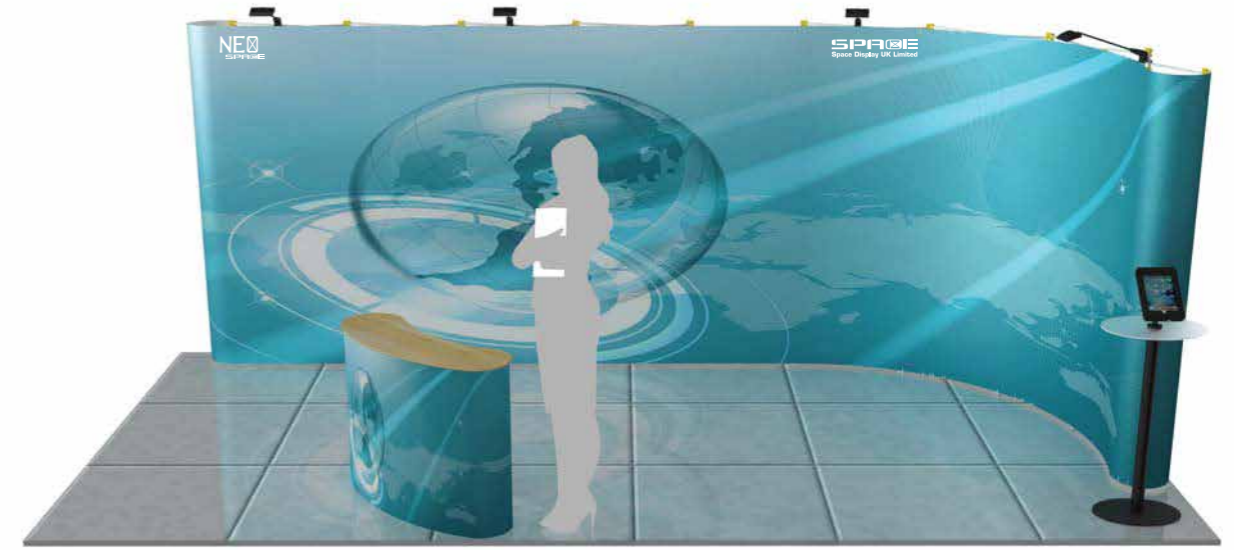
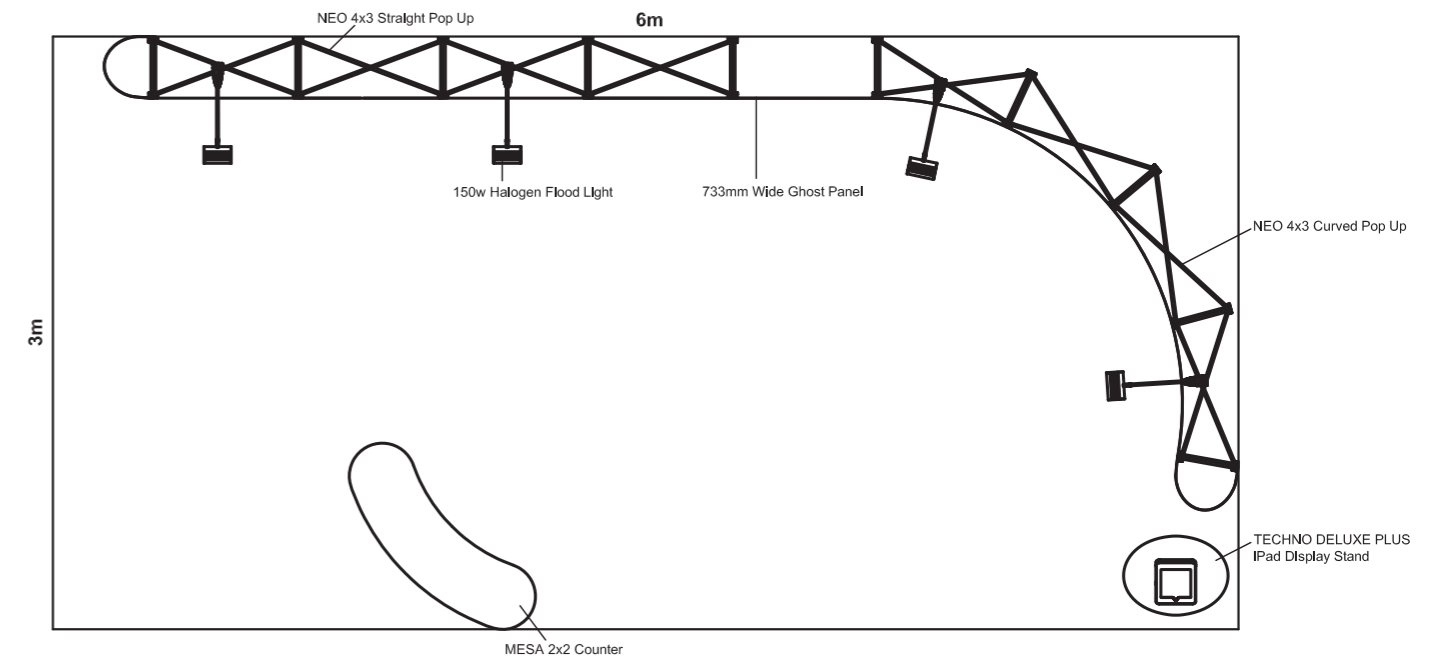

Products Required To Create Stand 4D

- ❖ 1 off NEO 4x3 Straight Pop Up Display Bundle
- ❖ 1 off NEO 4x3 Curved Pop Up Display Bundle
- ❖ 1 off MESA 2x2 Curved Pop Up Counter
- ❖ 1 off TECHNO Deluxe PLUS iPad Stands

Self-Build Exhibition Stand - 4E 6m x 3m Area With 1 Walls

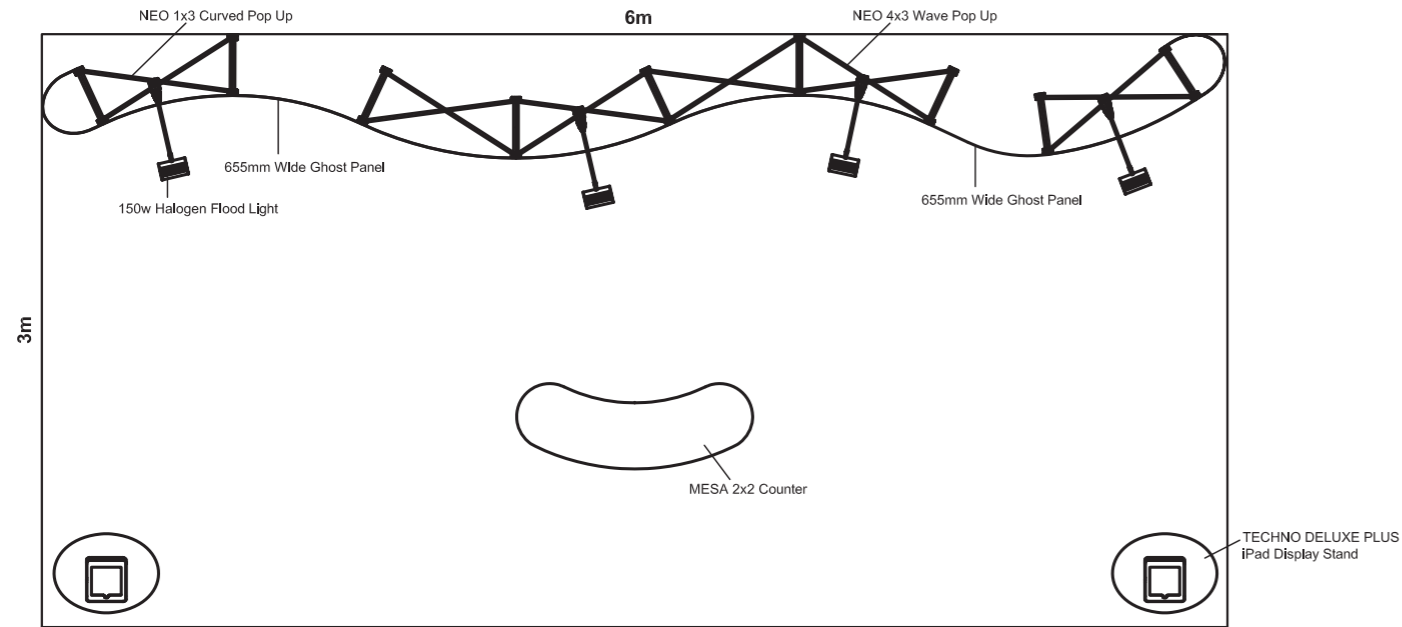

Self-Build Exhibition Stand - 4F 6m x 3m Area With 1 Wall

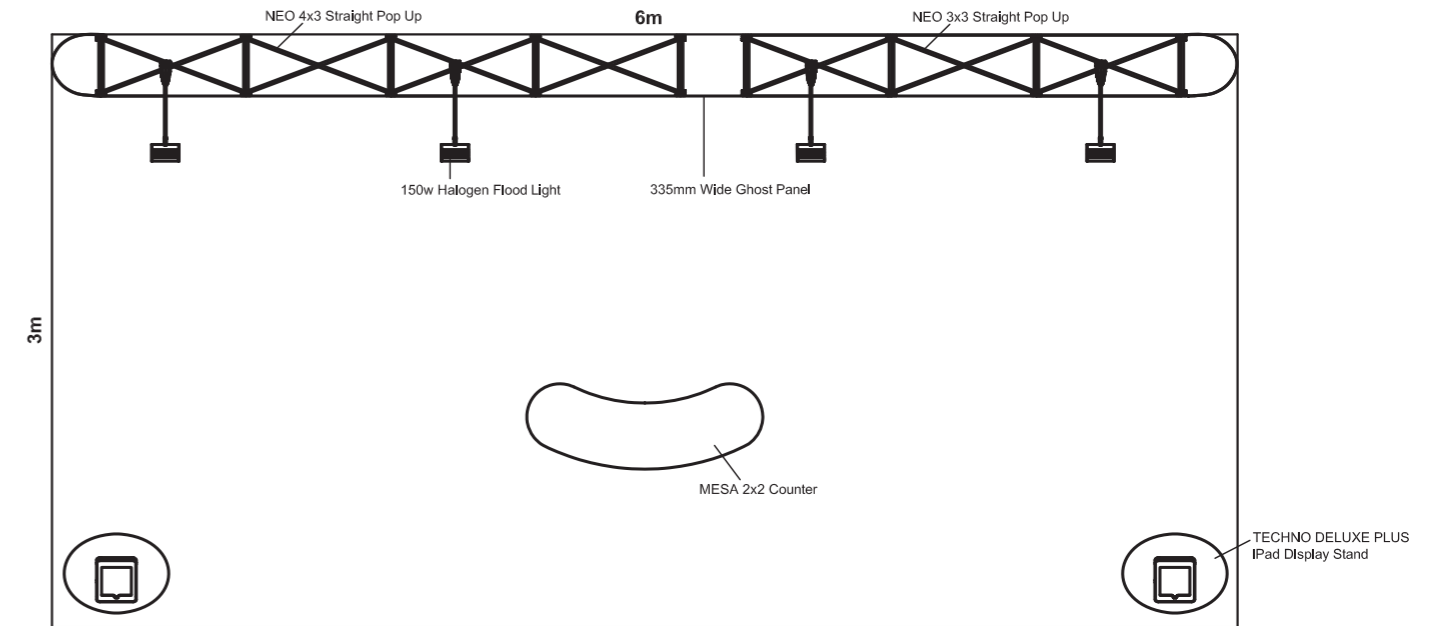

Products Required To Create Stand 4E

- ❖ 1 off NEO 4x3 Wave Pop Up Display Bundle
- ❖ 1 off NEO 3x3 Curved Pop Up Display Bundle
(To be split into 2 off 1x3 frames)
- ❖ 1 off Rear Button Magnets Kit for 3x3 NEO Frame
- ❖ 1 off MESA 2x2 Curved Pop Up Counter
- ❖ 2 off TECHNO Deluxe PLUS iPad Stands
- ❖ 1 off NEO 2x3 Curved System Rear Hanger & Kicker Set

Products Required To Create Stand 4F

- ❖ 1 off NEO 4x3 Straight Pop Up Display Bundle
- ❖ 1 off NEO 3x3 Straight Pop Up Display Bundle
- ❖ 1 off MESA 2x2 Curved Pop Up Counter
- ❖ 2 off TECHNO Deluxe PLUS iPad Stands

Self-Build Exhibition Stand - 5A 6m x 6m Area With No Walls

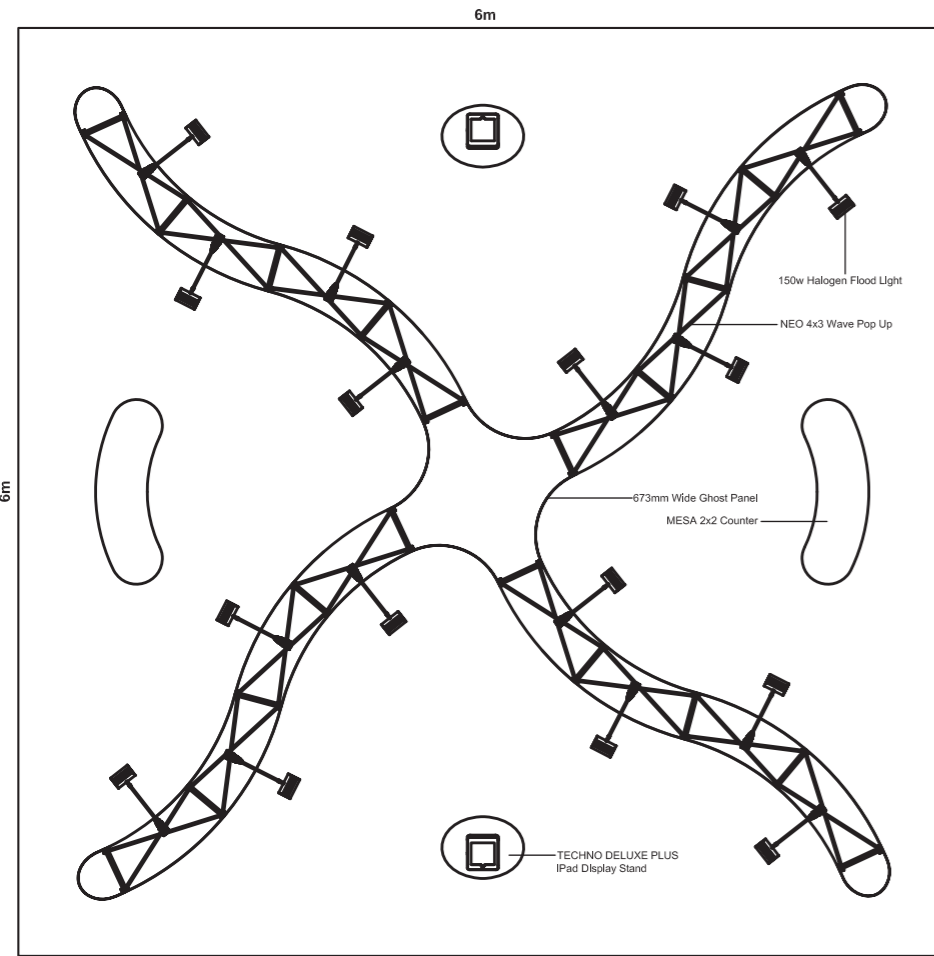

Products Required To Create Stand 5A

- ❖ 4 off NEO 4x3 Wave Pop Up Display Bundles
- ❖ 2 off MESA 2x2 Curved Pop Up Counters
- ❖ 2 off TECHNO Deluxe PLUS iPad Stands
- ❖ 4 sets of 2 x 150w Flood Lights
- ❖ 4 off NEO 4x3 Wave System Rear Upgrade Kits
- ❖ 4 off Rear Button Magnets Kit for 4x3 NEO Frame
- ❖ 3 Rolls of Magnetic Tape

Self-Build Exhibition Stand - 5B 6m x 6m Area With No Walls

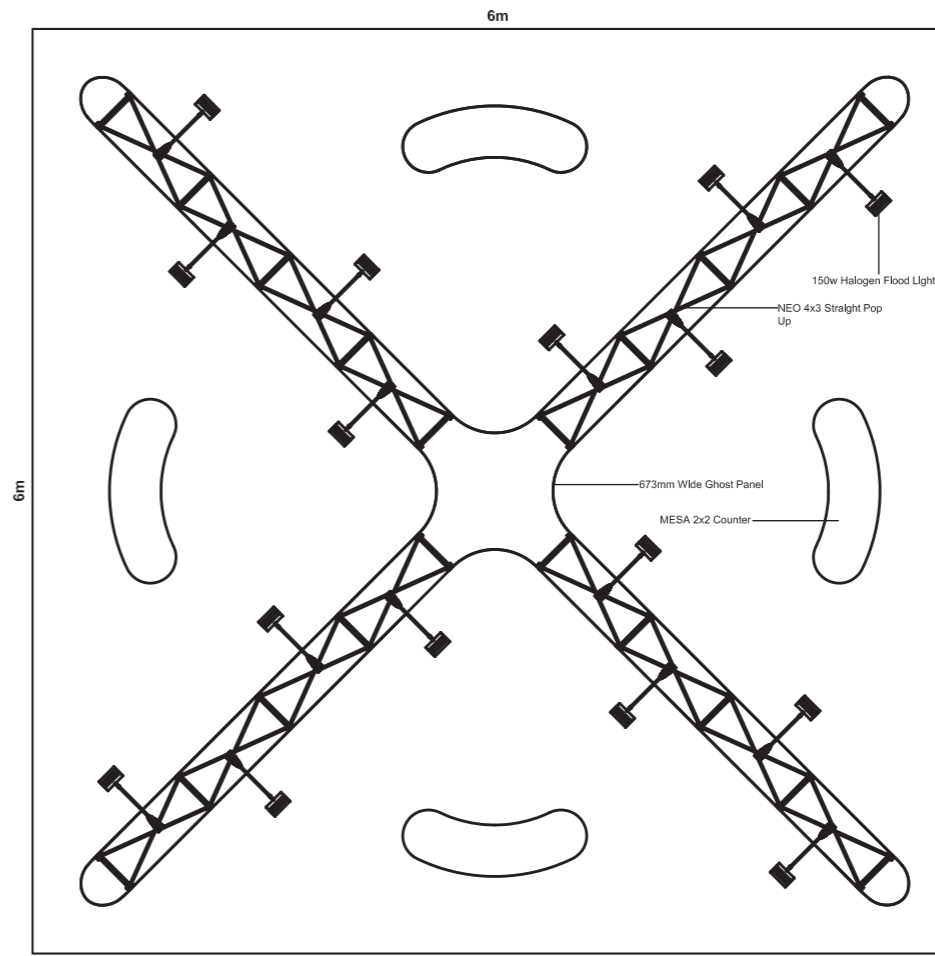

Products Required To Create Stand 5B

- ❖ 4 off NEO 4x3 Straight Pop Up Display Bundles
- ❖ 4 off MESA 2x2 Curved Pop Up Counters
- ❖ 4 sets of 2 x 150w Flood Lights
- ❖ 4 off NEO 4x3 Straight System Rear Upgrade Kits
- ❖ 4 off Rear Button Magnets Kit for 4x3 NEO Frame
- ❖ 3 Rolls of Magnetic Tape



MESA Pop Up Counter

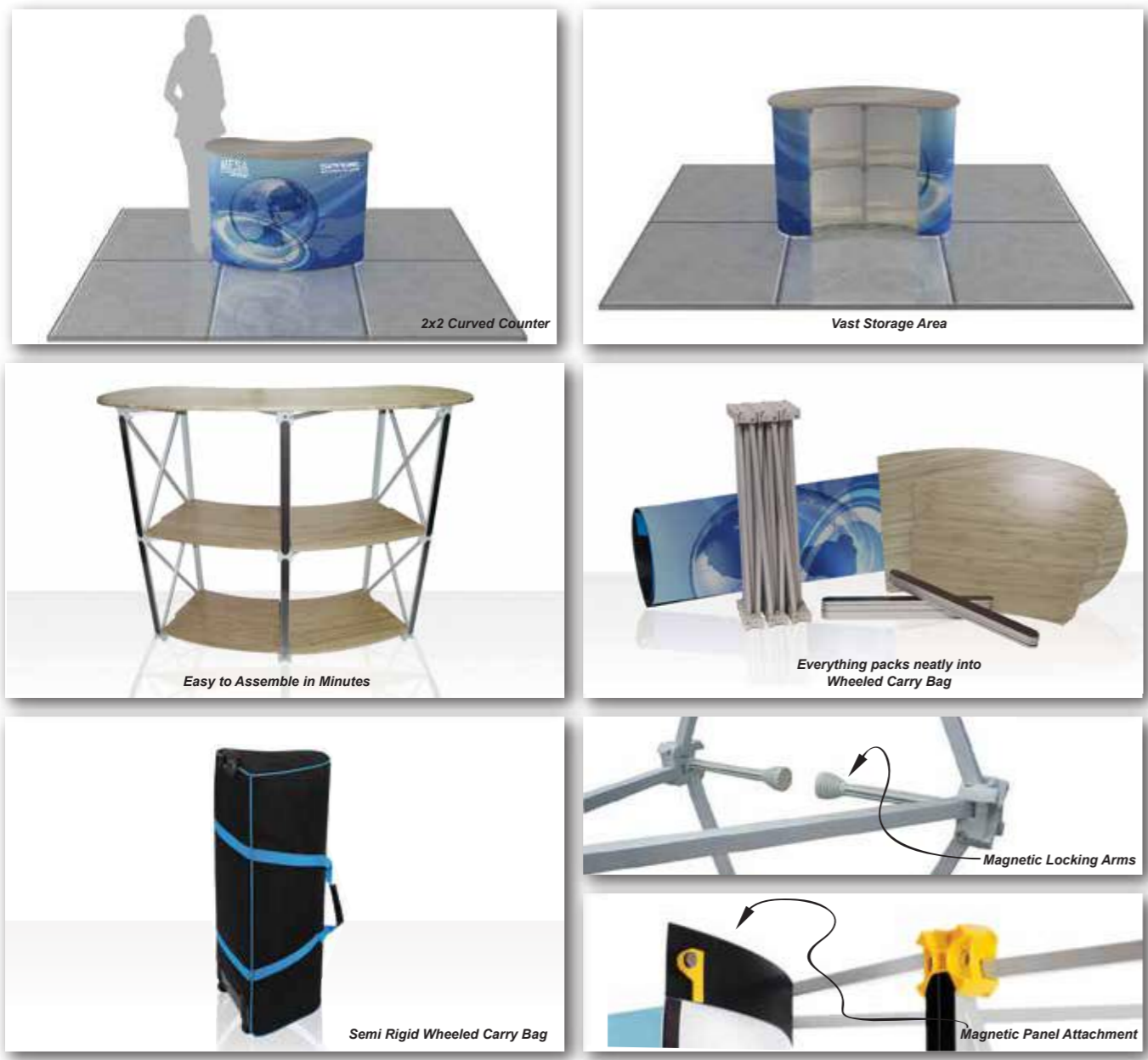

MESA Pop Up Tower Counter

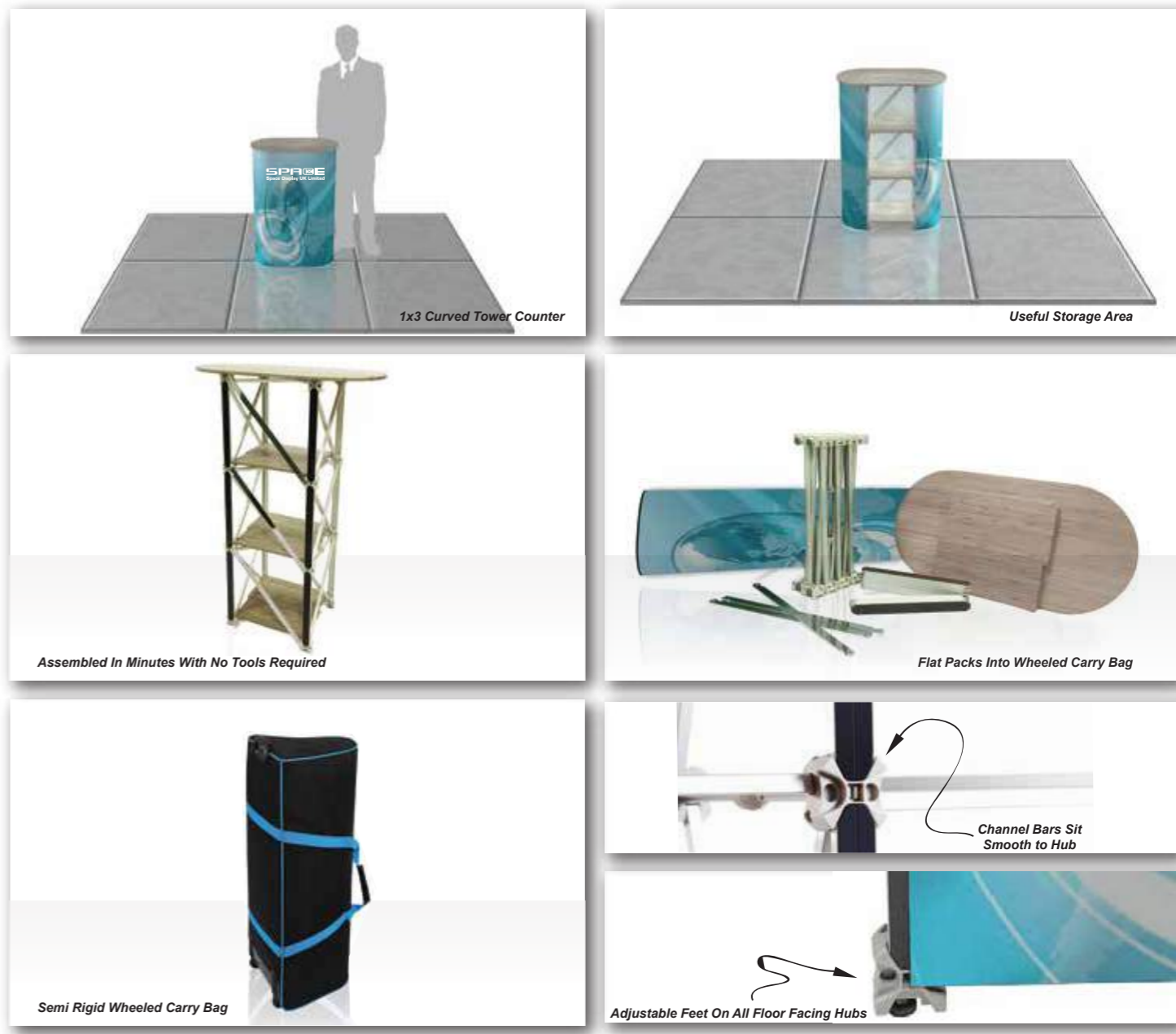

- ❖ Presenting the latest evolution of our highly successful Neo pop up system... new pop up counters. Fully magnetic, lightweight, flat pack display counters with frames manufactured from a silver box aluminium tubing for improved structural stability
- ❖ Features include twist out adjustable feet on all floor facing hubs, a single seamless magnetically attached graphic wrap and wooden counter top and internal shelves

- ❖ Quick and easy assembly... expand the frame, the magnetic arms will gently lock the structure into position, add the magnetic channel bars to the magnetic hubs, attach the one piece graphic wrap magnetically to the channel bars, and finally locate the counter top and the internal shelves
- ❖ Supplied in a smart wheeled, semi rigid carry bag, designed to take the complete counter & wrap
- ❖ MESA Counters are available in 2x2 curved frames and MESA Tower Counters in 1x3 curved frames

SATELLITE Tensioned Fabric Pop Up System

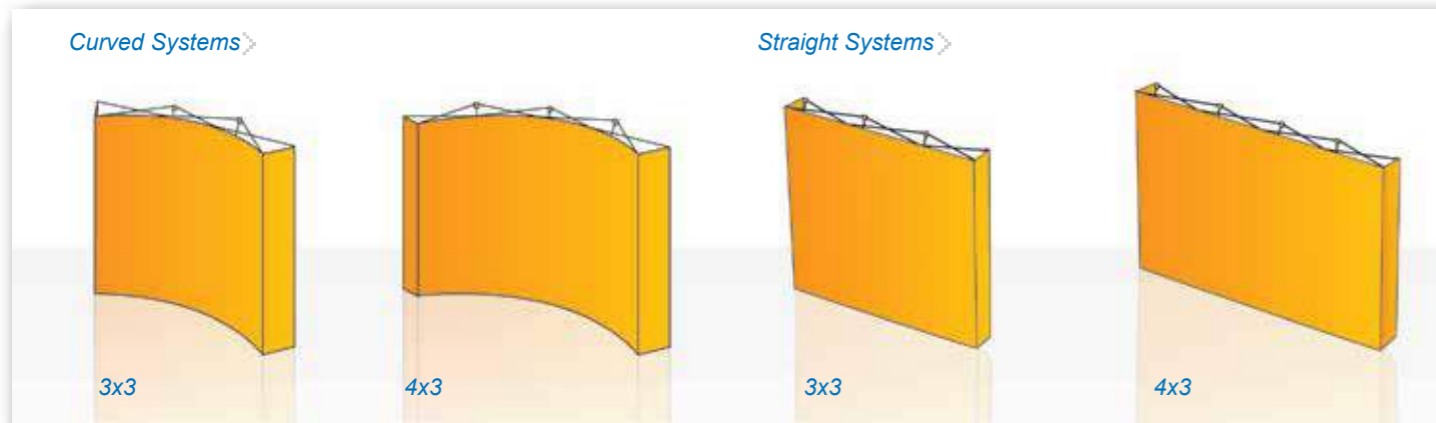

SATELLITE Tensioned Fabric Pop Up System

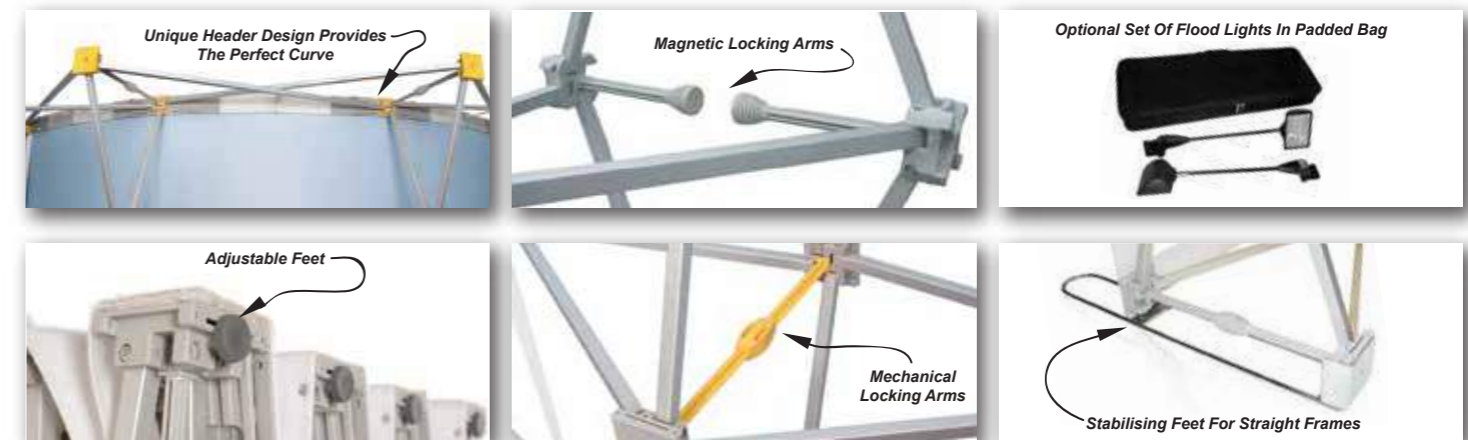

- ❖ Superb range of premium quality, tensioned fabric pop-up displays, featuring a strong and lightweight frame manufactured from a silver box aluminium tubing, which offers better structural stability than similar systems made with cylindrical aluminium tubing
- ❖ Assemble the system in only a few minutes, with no tools required. Simply expand the frame into position with the graphic already attached, connect the locking arms together and the stretch fabric graphic panel will become taught to create a truly seamless panoramic display. Finally attach the optional Flood Lights

- ❖ Available in straight or curved frame styles with a choice of 3x3 or 4x3 size frame configurations and supplied in a smart semi rigid wheeled carry bag. Frames also feature twist out adjustable feet on front floor facing hubs
- ❖ Less than half the weight of a traditional magnetic pop up display system and one of the most compact and highly portable display systems on the market. The soft stretch fabric graphic can remain permanently attached to the frame too

SATELLITE Tensioned Fabric Pop Up Counter



- ❖ Presenting the latest evolution of our highly successful, next generation SATELLITE Tensioned Fabric pop up system... New SATELLITE Pop Up Display Counters
- ❖ Extremely lightweight and highly portable pop up style display counter, with frames manufactured from a silver box aluminium tubing for improved structural stability
- ❖ Supplied in a padded carry bag with a padded pouch to protect the wooden counter top & shelf
- ❖ Assemble in a few minutes, simply expand the frame into position with the graphic already attached, connect the 4 locking arms together and the stretch fabric will become taught, then add the wooden counter top and internal shelf

ZING Literature Rack



- ❖ Highly portable flat pack literature unit offering quick and easy set up. Simply extend the frame upwards, until the self locking mechanism secures the system into position and then add your product literature
- ❖ Features six A4 portrait style brochure shelves, three on each side of the unit, for an extremely impressive double sided display
- ❖ Supplied in a stylish aluminium flight case offering perfect protection in transit

TECHNO DELUXE PLUS iPad Display Stand



TECHNO Deluxe PLUS iPad Display Stand

Snap rail fittings for the graphic are included

- ❖ Extremely stylish and highly versatile, freestanding iPad/Tablet display stand, with the option to add a rollable graphic panel or custom shaped rigid graphics to the vertical post
- ❖ Smart black anodised aluminium post with a matt black weighted base and a frosted acrylic table top. Supplied in a padded carry bag for added protection in transit, plus a graphic tube/graphic kit
- ❖ The steel cradle has a secure lock and offers 360 degree rotation, plus tilt and swivel feature and is designed to hold iPad 2,3, 4 and Air, and a portable charger
- ❖ This products offers the perfect solution for impressive interactive product presentations at any exhibition, event or showroom

TECHNO DELUXE iPad Display Stand

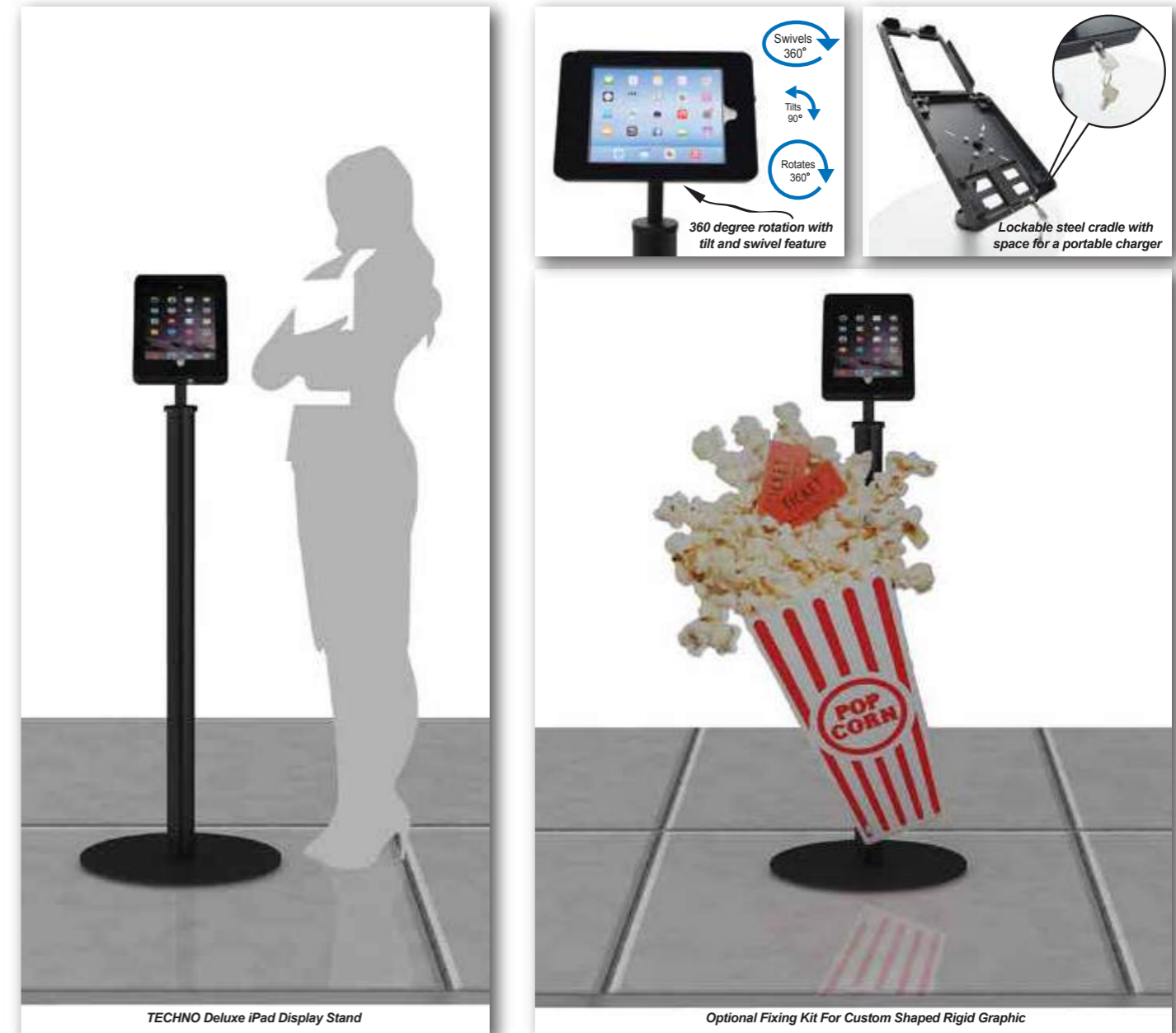

TECHNO Deluxe iPad Display Stand

Optional Fixing Kit For Custom Shaped Rigid Graphic

- ❖ Highly versatile, freestanding iPad/Tablet display stand, designed to hold iPad 2,3, 4 and Air, and a portable charger
- ❖ Presented with a smart black anodised aluminium post, plus a heavy duty laser cut steel base and a lockable steel cradle that offers 360 degree rotation, plus tilt and swivel features
- ❖ Optional graphic fixing kit to mount custom shaped rigid graphics to the vertical post, with quick and easy thumb-screw style assembly in only a few seconds
- ❖ This system offers quick and easy assembly in only a few minutes and is an ideal solution to any permanent or semi permanent interactive presentation

LINK Roller Banner Wall

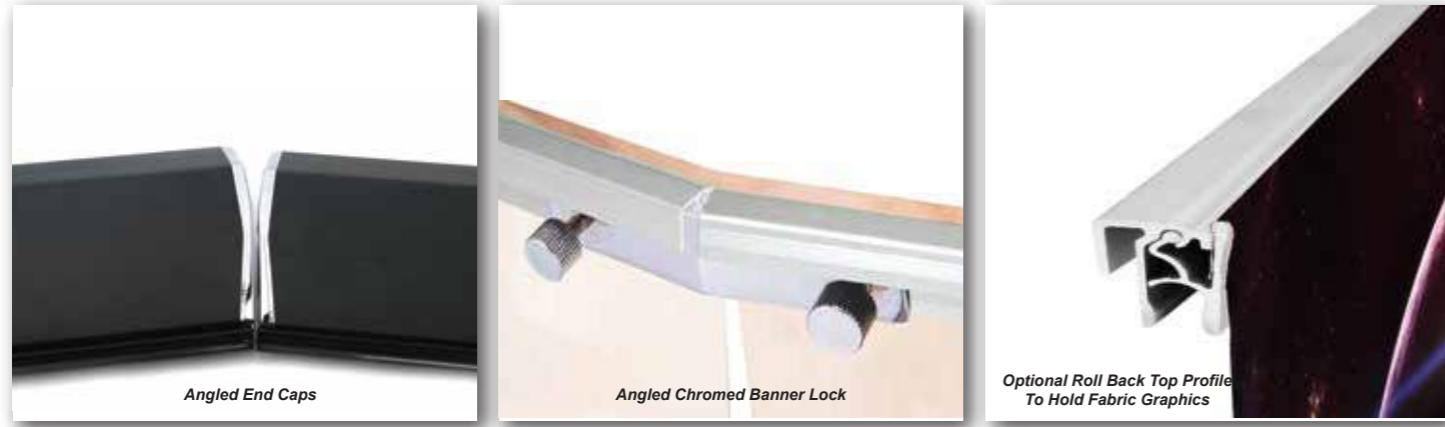
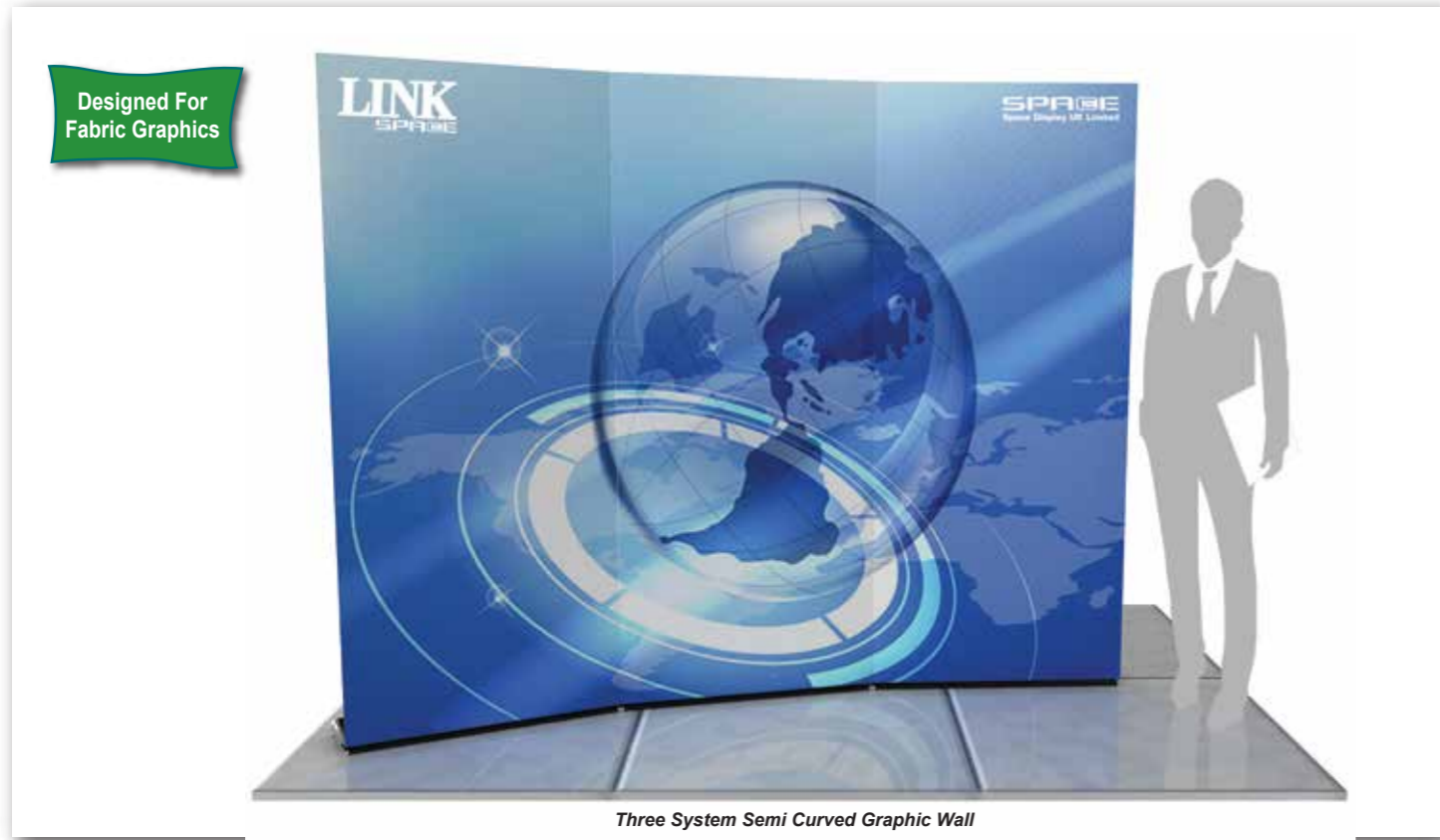

- ❖ Ultra modern designer styled system, presented in a sleek satin black finish, with highly durable 10mm thick, chrome plated steel end caps
- ❖ The uniquely engineered angled base allows multiple systems to sit together to create almost seamless, semi curved landscape graphic walls
- ❖ The top graphic bars are also securely connected together with angled banner linking brackets and the low profile front design of the base unit also ensures you see more graphic from the front view than most other roller banners too

LINK Roller Banner Wall



- ❖ Changing graphics is easy, simply extend it from the base, replace the locking pin, push the buttons on end caps, remove the complete top section of the base, then remove the old graphic and snap-in or slide-on a new graphic
- ❖ This system offers a lightweight, highly portable landscape graphic solution for use at any exhibition or event

SUPREME Roller Banner



SUPREME Roller Banner



- ❖ Elegant and eye catching designer system with sleek low profile styling, presented in a smart satin silver anodised finish with cool chrome plated end caps. One of our best selling roller banners for many years
- ❖ First system to feature our patented "Click-The-Button" graphic change feature that reduces the lengthy process of graphic switching to less than 30 seconds
- ❖ Changing graphics is easy, simply extend it from the base, replace the locking pin, push the buttons on the end caps, flip open the lid, remove the cartridge, slide the old graphic off the cartridge and slide on a new one

- ❖ Wide base design and adjustable feet allow the system to stand up straight and tall on the most uneven of surfaces
- ❖ Offered in a choice of 850mm, 1000mm, 1200mm and 1500mm widths and supplied in a luxury padded carry
- ❖ Options include a telescopic pole that extends from 1000mm to 2150mm or a clip on 50w low voltage spot light which comes in a padded carry bag

DUAL Roller Banner



- ❖ Elegant and eye catching double sided version of our top selling Supreme roller banner, presented in a stylish satin silver anodised finish, also features our patented "Click-The-Button" feature
- ❖ Changing graphics is easy, simply extend the graphic from the base, replace the locking pin, push the buttons on the end caps, flip open the lid, remove the cartridge, slide the old graphic from the cartridge and slide on a new one
- ❖ Wide base design and twist out adjustable feet allow the system to stand up straight and tall on the most uneven of surfaces. Available in 850mm and 1000mm widths, supplied in a semi rigid padded carry bag

MINI Roller Banner



- ❖ Compact and modern design with subtle styling and clean lines, presented in a smooth satin silver anodised finish with feature chromed steel end caps
- ❖ Switching graphics is easy, simply extend the graphic from the base, replace the locking pin, loosen the Allen Key screw on each end cap, flip open the lid, remove the cartridge, slide the old graphic from the cartridge and snap in or slide on a new one
- ❖ The removable cast aluminium foot together with two adjustable feet on the base, help stabilise this system on any uneven floors. Offered in 600m, 850mm and 1000mm widths, supplied in a padded carry bag. Optional 50w low voltage spot light in a padded carry bag also available

SCROLL MC Roller Banner



- ❖ Updated version of our top selling SCROLL system, retaining the stylish appearance and innovative streamline design, presented in a brilliant satin silver anodised finish with chromed steel end caps
- ❖ Ultra slim end caps allow you to create an almost seamless graphic wall by positioning multiple systems together in a straight line
- ❖ Optional telescopic pole or 50w spot light in a padded carry bag
- ❖ Available in 850mm and 1000mm widths and supplied in a padded carry bag

FINESSE Roller Banner



- ❖ Contemporary designer styled system, presented in a smooth satin silver anodised finish with contrasting textured grey steel end caps
- ❖ Available in an 850mm width with a 2140mm high visual graphic area, supplied in a padded carry bag and offered with optional telescopic pole or 50w low voltage spot light
- ❖ Ultra slim end caps allow multiple systems to be positioned together in straight lines with Magnetic Banner Locks, to create imposing landscape style displays
- ❖ A superb product offering exceptionally good value for money

AXIS Roller Banner



- ❖ Compact and lightweight system, presented in a smart satin silver anodised finish, designed to be a highly effective marketing tool at a cost effective price
- ❖ Features include stylish twin twist out chrome plated wire feet and chrome plated steel end caps for a touch of elegance
- ❖ Available in 600mm, 850mm, 1000mm and 1200mm widths, supplied in a padded carry bag, optional 50w low voltage spot light

RACE Roller Banner



- ❖ Lightweight and well designed entry level roller banner offering exceptional value for money, this system will certainly outperform other similar products on the market
- ❖ A simple marketing tool at the right price offering the ideal solution. It's compact and lightweight aluminium casing and twist out stabilising feet offer quick and easy assembly in seconds.
- ❖ Supplied in a padded carry bag and now available in 850mm and new 800mm width
- ❖ Create low cost graphic walls by connecting multiple systems together with magnetic locks. Magnetic banner locks can only be used with Snap Top Rail version of this product.

DASH Roller Banner



- ❖ Double sided, lightweight and well designed, entry level system offering incredible value for money, this system will definitely outperform other similar products on the market
- ❖ If you need a simple double sided marketing tool at the right price, then this is the only solution. It's compact aluminium casing and chrome twist out stabilising foot offer rapid assembly in only a few seconds. Available in an 850mm width and supplied in a padded carry bag

LITE Tensioned Banner Wall

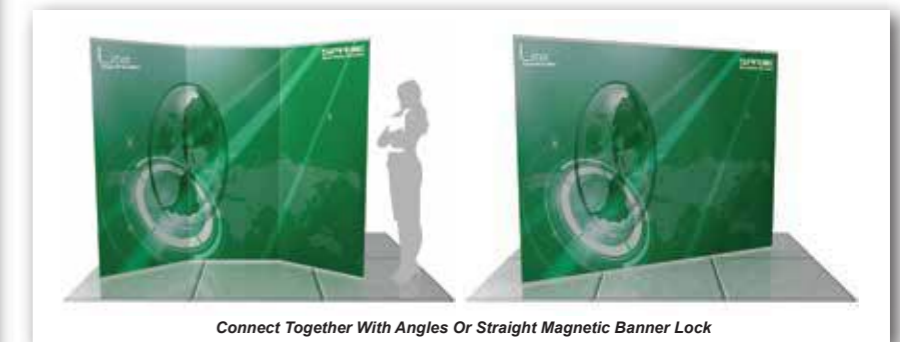
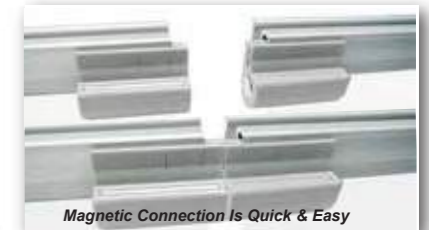

- ❖ One of our top selling banner stands, offering stylish presentation at an affordable price
- ❖ Easy to set up with assembly in four 4 simple steps, so can be done in seconds!
- ❖ Lightweight cast aluminium foot together with the weighted pole create greater stability than other similar systems on the market
- ❖ Offers greater flexibility than a roller banner, as systems can be linked together in seconds with our 'Magnetic Banner Locks' to create impressive seamless graphic walls as long as you wish
- ❖ Available in 600mm, 850mm, 1000mm and 1200mm widths, supplied in a cylindrical carry bag

MAGNETIC BANNER LOCKS - Angled & Straight-NEW



- ❖ Create impressive, low cost graphic walls by connecting LITE Tensioned Banners together with Angled or Straight 'Magnetic Banner Locks'
- ❖ Simple to use magnetic connection means assembly takes only a few seconds

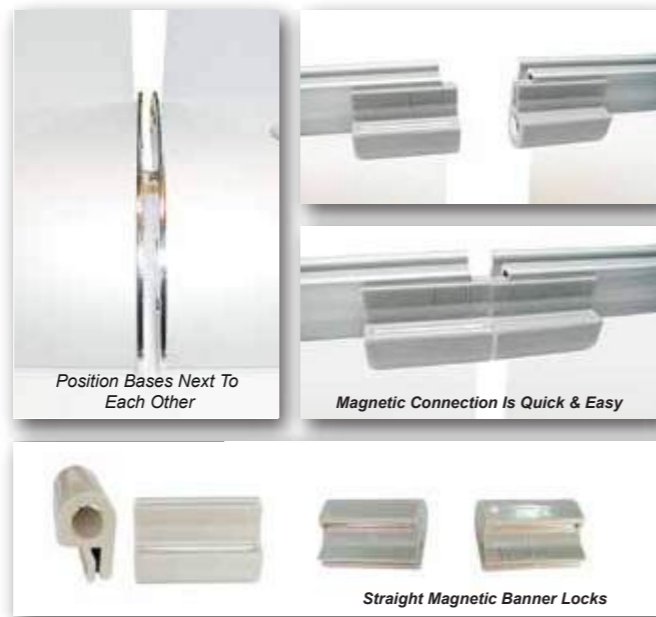

- ❖ Connect multiple Roller Banners together with Straight 'Magnetic Banner Locks' to create impressive landscape style graphic walls
- ❖ Straight 'Magnetic Banner Locks' suit DUAL, SUPREME, MINI, SCROLL MC and FINESSE Roller Banners

SPYDER X-Banner - NEW



- ❖ An ultra lightweight Tensioned X-Banner system, offering an extremely cost effective graphic display solution
- ❖ Quick and easy assembly in only a couple of minutes... expand the tripod style base into position... attach the two poles to the central hub... locate the graphic on the pips of each of these poles, then on the pips on the two lower poles, using the eyelets on the graphic
- ❖ This product is supplied in a simple drawstring carry bag and the graphic has a visual area of 1800mm x 800mm

GRAPHIC SPECIFICATIONS		ISSUE 12	January 2020
PREMIUM RANGE ROLLER BANNERS			VISUAL AREA
25085SP	LINK 850mm roller banner		2150mm x 850mm
25085SP	LINK 850mm roller banner-FABRIC PRINT WITH REVERSE TOP RAIL		2180mm x 850mm
7085SP	SUPREME 850mm roller banner		2150mm x 850mm
7100SP	SUPREME 1000mm roller banner		2150mm x 1000mm
7120SP	SUPREME 1200mm roller banner		2150mm x 1200mm
7150SP	SUPREME 1500mm roller banner		2150mm x 1500mm
8085SP	DUAL 850mm twin sided roller banner		2150mm x 850mm
8100SP	DUAL 1000mm twin sided roller banner		2150mm x 1000mm
MID RANGE ROLLER BANNERS			VISUAL AREA
3060SP	MINI 600mm roller banner		1800mm x 600mm
3085SP	MINI 850mm roller banner		2150mm x 850mm
3100SP	MINI 1000mm roller banner		2150mm x 1000mm
2085MCSP	SCROLL MC 850mm roller banner		2150mm x 850mm
2100MC SP	SCROLL MC 1000mm roller banner		2150mm x 1000mm
30085SP	FINESSE 850mm roller banner		2140mm x 850mm
6060	AXIS 600mm roller banner		1600mm x 600mm
6085	AXIS 850mm roller banner		2000mm x 850mm
6100	AXIS 1000mm roller banner		2000mm x 1000mm
6120	AXIS 1200mm roller banner		2000mm x 1200mm
ENTRY LEVEL ROLLER BANNERS			VISUAL AREA
17085	RACE 850mm roller banner		2000mm x 850mm
17085	RACE 800mm roller banner		2000mm x 800mm
19085	DASH 850mm twin sided roller banner		2000mm x 850mm
TENSION BANNER STANDS			VISUAL AREA
4060SP	LITE 600mm tension banner		1800mm x 600mm
4085SP	LITE 850mm tension banner with snap rails		2150mm x 850mm
4100SP	LITE 1000mm tension banner with snap rails		2150mm x 1000mm
4120SP	LITE 1200mm tension banner with snap rails		2150mm x 1200mm
DSP-A02	SPYDER 800mm X-Banner Tension Banner		1800mm x 800mm
POP UP DISPLAY SYSTEMS - FOR MAGNETICALLY ATTACHED GRAPHICS			VISUAL AREA
NEO-CUR-23	NEO 2x3 Curved Frame	Front/Inside Curved Panel	2225mm x 673mm
		End Cap Panel	2225mm x 673mm
		Rear/Outside Curved Panel	2225mm x 808mm
NEO-CUR-33	NEO 3x3 Curved Frame	Front/Inside Curved Panel	2225mm x 673mm
		End Cap Panel	2225mm x 673mm
		Rear/Outside Curved Panel	2225mm x 808mm
NEO-CUR-43	NEO 4x3 Curved Frame	Front/Inside Curved Panel	2225mm x 673mm
		End Cap Panel	2225mm x 673mm
		Rear/Outside Curved Panel	2225mm x 808mm
NEO-STR-23	NEO 2x3 Straight Frame	Front/Rear Panel	2225mm x 733mm
		End Cap Panel	2225mm x 673mm
NEO-STR-33	NEO 3x3 Straight Frame	Front / Rear Panel	2225mm x 733mm
		End Cap Panel	2225mm x 673mm
NEO-STR-43	NEO 4x3 Straight Frame	Front / Rear Panel	2225mm x 733mm
		End Cap Panel	2225mm x 673mm
NEO-WAV-43	NEO 4x3 Wave Frame	Front / Rear Concave Curved Panel	2225mm x 673mm
		End Cap Panel	2225mm x 673mm
		Front / Rear Convex Curved Panel	2225mm x 808mm
POP UP CASE GRAPHIC WRAPS			VISUAL AREA
n/a	Pop Up Case Graphic Wrap - V1 Case With 4 Silver Locks		1800mm x 800mm
n/a	Pop Up Case Graphic Wrap - V2 Case With 3 Silver Locks		1730mm x 800mm
n/a	Pop Up Case Graphic Wrap - V3 Case With 3 Black Locks		1795mm x 810mm
POP UP DISPLAY SYSTEMS - FOR TENSIONED FABRIC GRAPHICS			VISUAL AREA
SAT-CUR-33	SATELLITE 3x3 Curved Frame	Front/Inside Curved Panel	2250mm x 2067mm
		End Cap Panel	2250mm x 355mm
SAT-CUR-43	SATELLITE 4x3 Curved Frame	Front/Inside Curved Panel	2250mm x 2738mm
		End Cap Panel	2250mm x 355mm
SAT-STR-33	SATELLITE 3x3 Straight Frame	Front / Rear Panel	2250mm x 2250mm
		End Cap Panel	2250mm x 355mm
SAT-STR-34	SATELLITE 4x3 Straight Frame	Front / Rear Panel	2250mm x 2982mm
		End Cap Panel	2250mm x 355mm
POP UP DISPLAY SYSTEMS - FOR SILICONE EDGE FABRIC GRAPHICS / SEG			VISUAL AREA
41133WB	EDGE 3x3 Curved Frame	Front/Inside Curved Panel	2285mm x 2110mm
		End Cap Panel	2285mm x 285mm
41143WB	EDGE 4x3 Curved Frame	Front/Inside Curved Panel	2285mm x 2790mm
		End Cap Panel	2285mm x 285mm
41033WB	EDGE 3x3 Straight Frame	Front / Rear Panel	2285mm x 2285mm
		End Cap Panel	2285mm x 285mm
41043WB	EDGE 4x3 Straight Frame	Front / Rear Panel	2285mm x 3015mm
		End Cap Panel	2285mm x 285mm
POP UP LIGHT BOX SYSTEMS - FOR SILICONE EDGE FABRIC GRAPHICS / SEG			VISUAL AREA
TBA	EDGE 1x2 Straight Light Box Frame	Front Panel	1555mm x 825mm
TBA	EDGE 1x3 Straight Light Box Frame	Front Panel	2285mm x 825mm
TBA	EDGE 2x3 Straight Light Box Frame	Front Panel	2285mm x 1555mm
TBA	EDGE 3x3 Straight Light Box Frame	Front Panel	2285mm x 2285mm
TBA	EDGE 4x3 Straight Light Box Frame	Front Panel	2285mm x 3015mm
POP UP DISPLAY COUNTERS			VISUAL AREA
MES-CUR-22	MESA 2x2 Curved Counter		2024mm x 885mm
MES-CUR-13	MESA 1x3 Curved Tower Counter		1345mm x 1000mm
SAT-34011	SATELLITE 1x1 Straight Counter		1700mm x 980mm
4101LAM	EDGE 1x1 Straight Counter		1580mm x 1010mm
IPAD DISPLAY STANDS			VISUAL AREA
32001-PLUS	TECHNO DELUXE PLUS - iPad/Tablet Stand		420mm x 960mm



SPACE
Space Display UK Limited

The Old Barn, Avoncroft Farm, Offenham,
Evesham, Worcestershire WR11 8RR
United Kingdom

Web: www.spacedisplay.co.uk
info@spacedisplay.co.uk

Issue No.13 - 01/20