

NEO Pop-up 2x3 Curved System

Front View - Stand Size

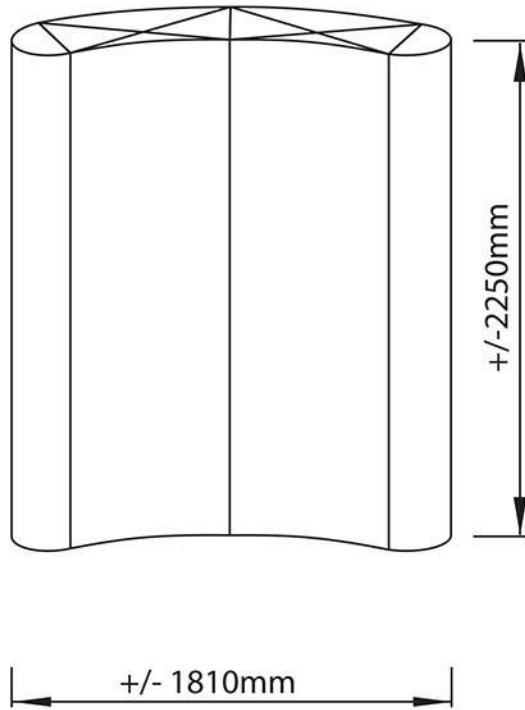

Panel Size

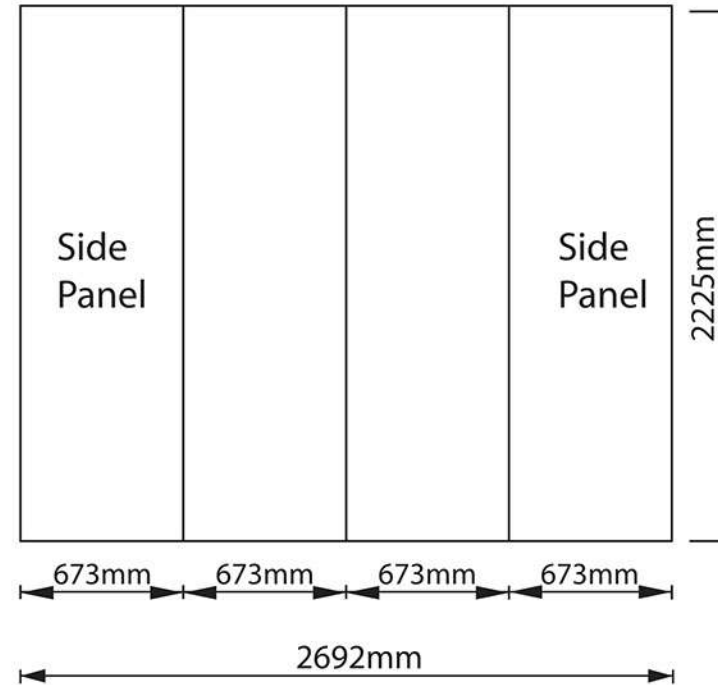

Top View - Stand Size

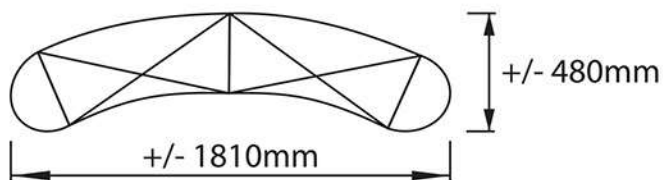

Remark:

1. Please avoid putting small text on the cutting lines.

2. Please note the outer half of the side panels will turn to the back after set up and would not be visible when standing in the front

3. Please submit the file in the panel size of 2692mmW x 2225mmH

NEO Pop-up 2x3 Straight System

Front View - Stand Size

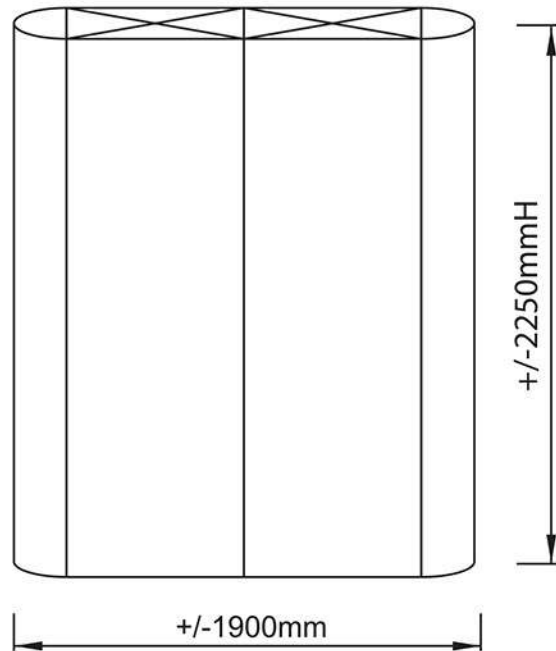

Panel Size

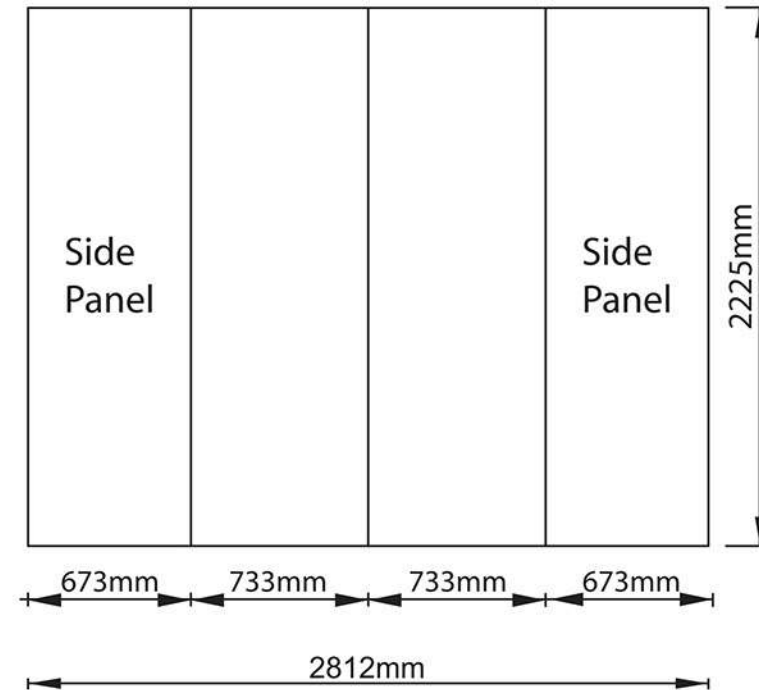

Top View - Stand Size

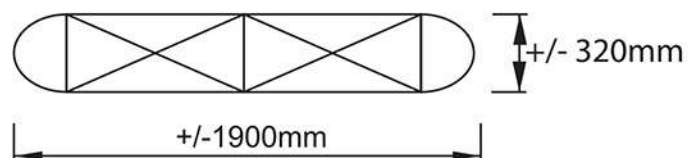

Remark:

1. Please avoid putting small text on the cutting lines.
2. Please note the outer half of the side panels will turn to the back after set up and would not be visible when standing in the front
3. Please submit the file in the panel size of 2812mmW x 2225mmH

NEO Pop-up 3x3 Curved System

Front View - Stand Size

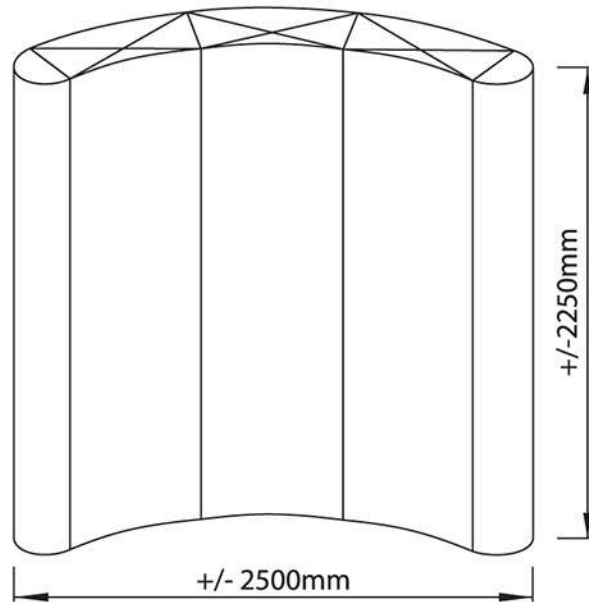

Panel Size

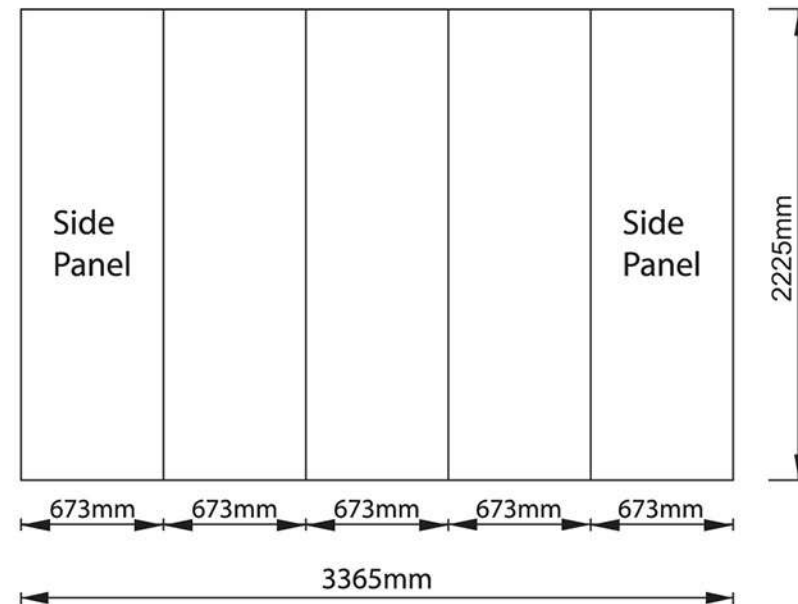

Top View - Stand Size

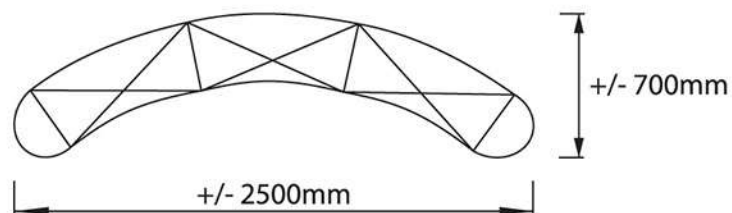

Remark:

1. Please avoid putting small text on the cutting lines.
2. Please note the outer half of the side panels will turn to the back after set up and would not be visible when standing in the front
3. Please submit the file in the panel size of $3365\text{mmW} \times 2225\text{mmH}$

NEO Pop-up 3x3 Straight System

Front View - Stand Size

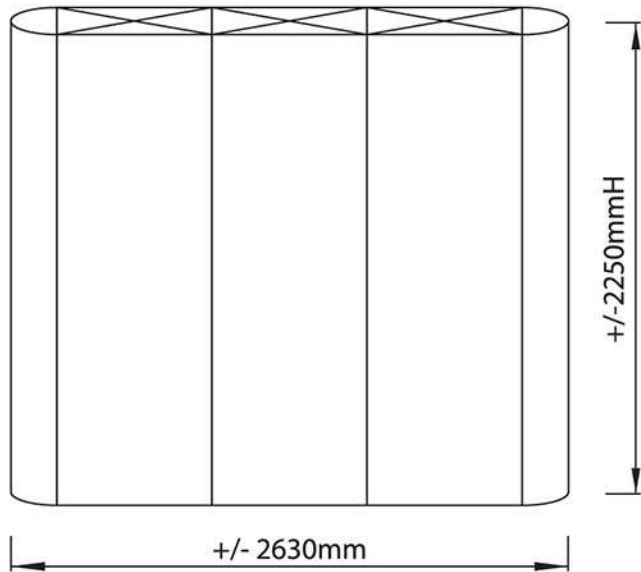

Panel Size

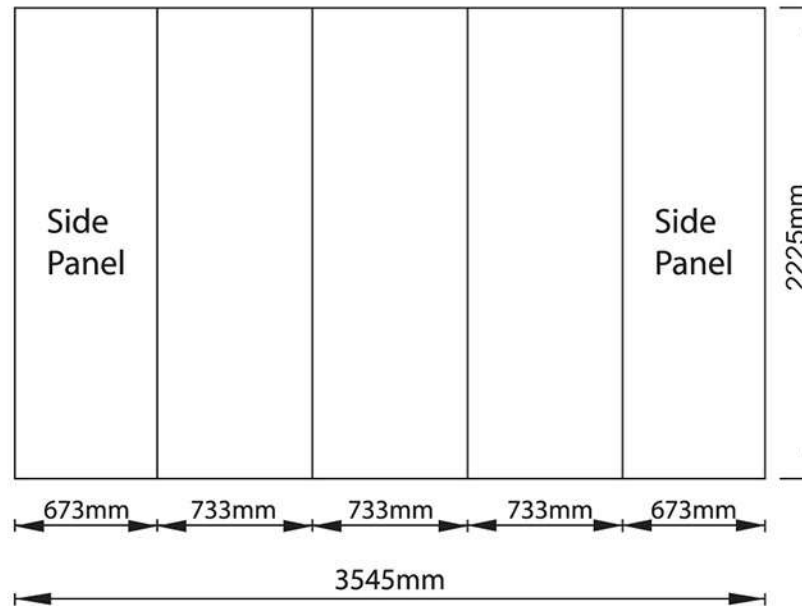

Top View - Stand Size

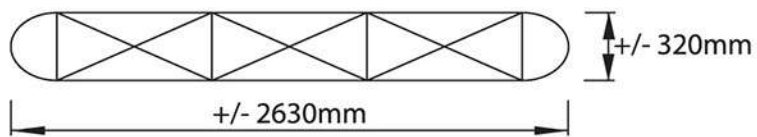

Remark:

1. Please avoid putting small text on the cutting lines.
2. Please note the outer half of the side panels will turn to the back after set up and would not be visible when standing in the front
3. Please submit the file in the panel size of 3545mmW x 2225mmH

NEO Pop-up 4x3 Curved System

Front View - Stand Size

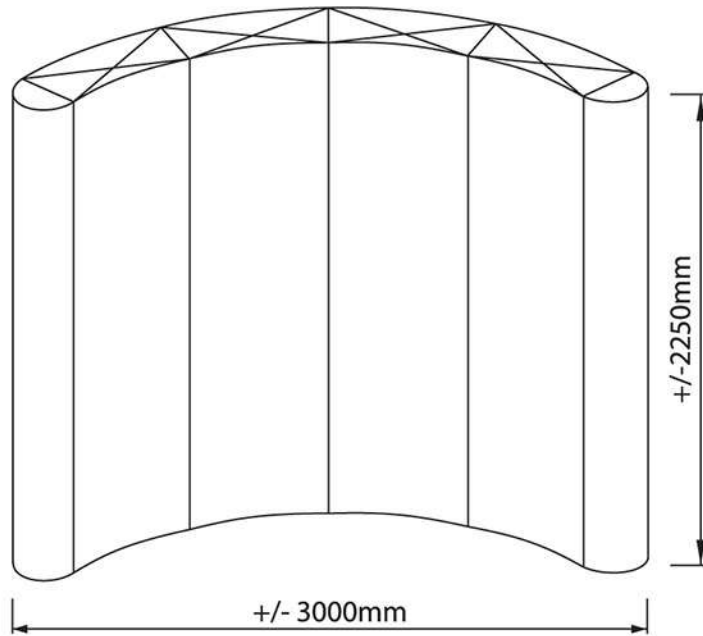

Panel Size

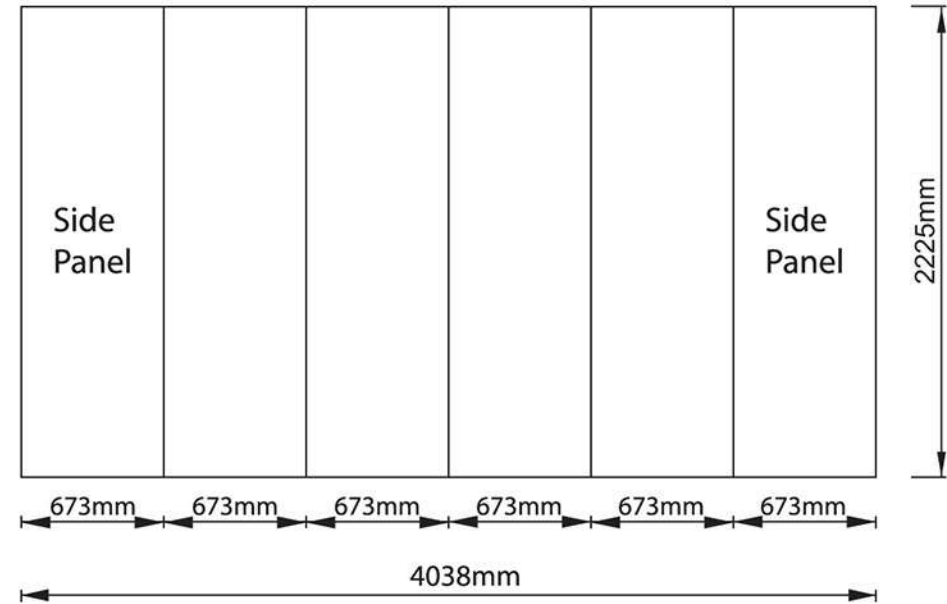

Top View - Stand Size

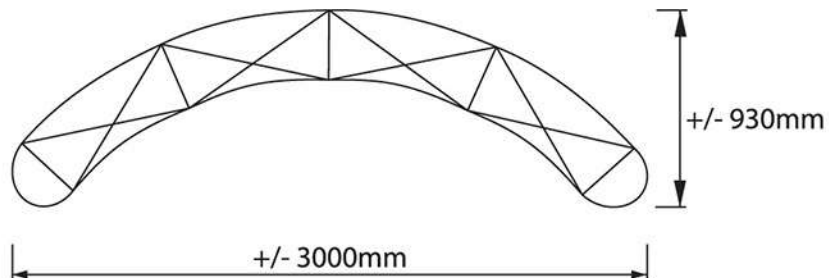

Remark:

1. Please avoid putting small text on the cutting lines.
2. Please note the outer half of the side panels will turn to the back after set up and would not be visible when standing in the front
3. Please submit the file in the panel size of 4038mmW x 2225mmH

NEO Pop-up 4x3 Straight System

Front View - Stand Size

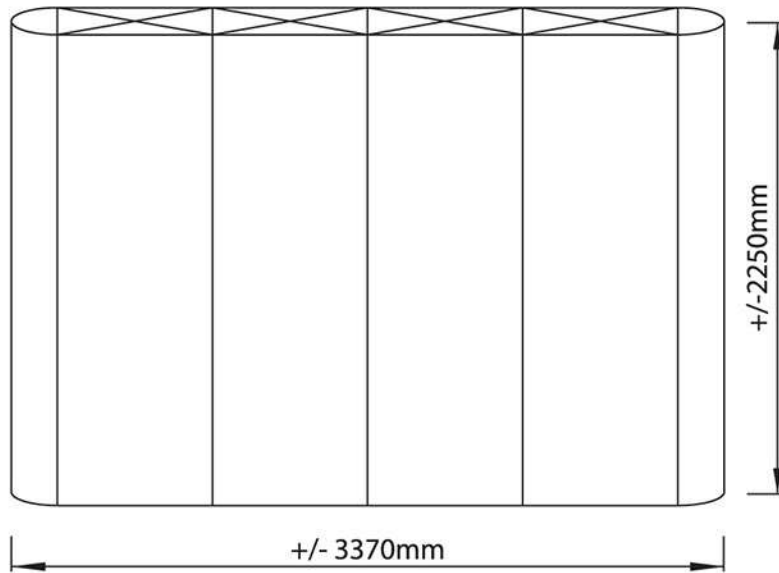

Panel Size

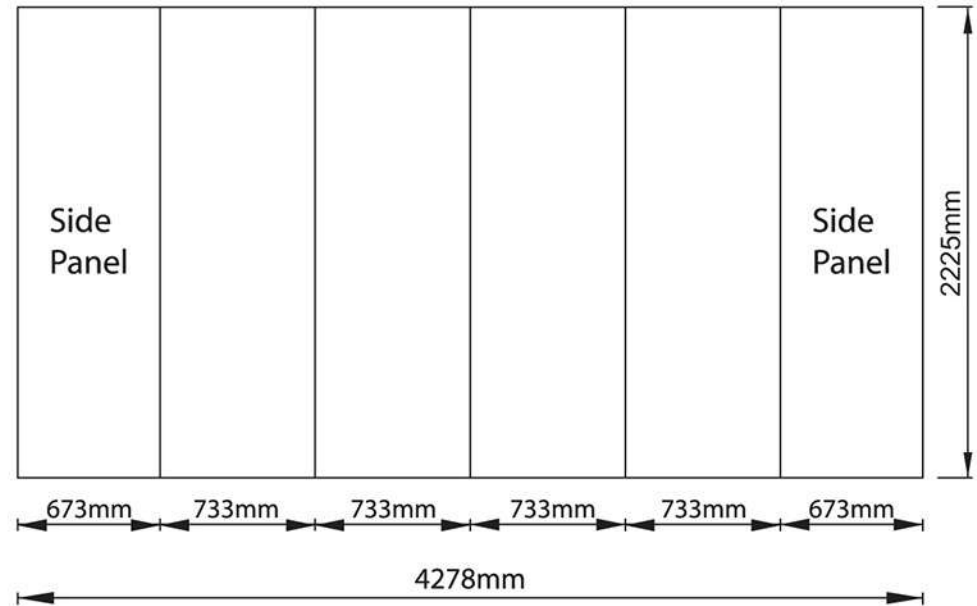

Top View - Stand Size

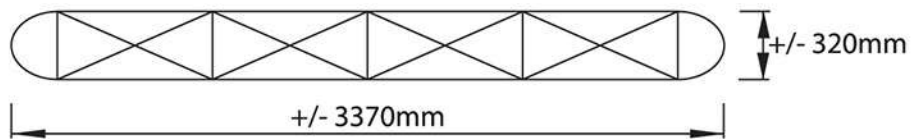

Remark:

1. Please avoid putting small text on the cutting lines.
2. Please note the outer half of the side panels will turn to the back after set up and would not be visible when standing in the front
3. Please submit the file in the panel size of 4278mmW x 2225mmH

NEO Pop-up 4x3 WAVE System

Front View - Stand Size

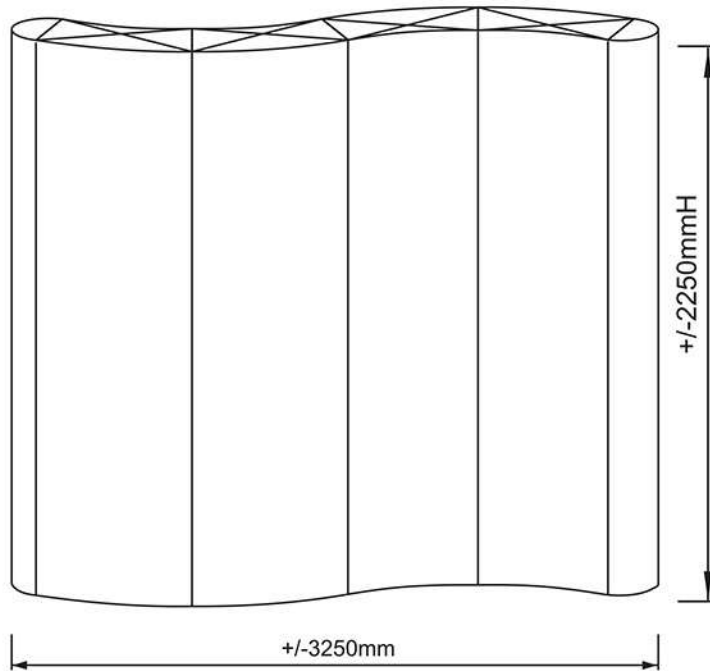

Top View - Stand Size

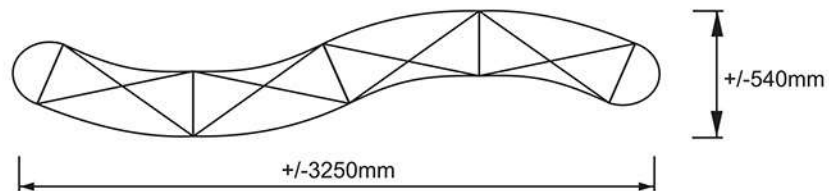

Panel Size

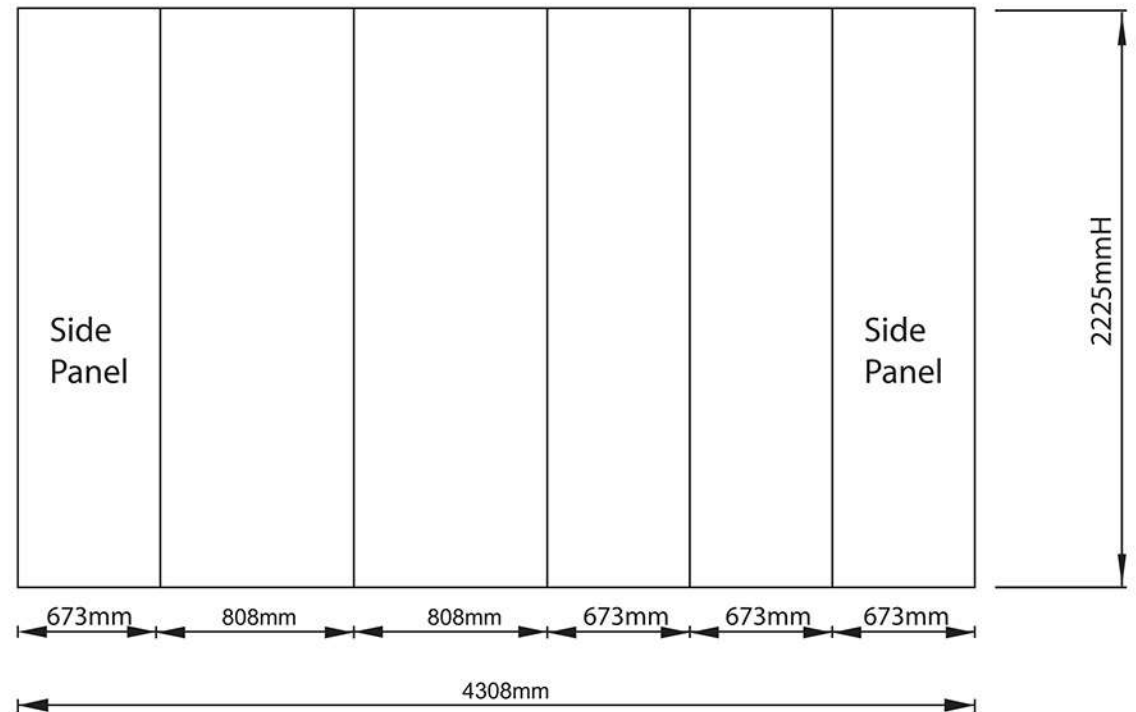

Remark:

1. Please avoid putting small text on the cutting lines.
2. Please note the outer half of the side panels will turn to the back after set up and would not be visible when standing in the front
3. Please submit the file in the panel size of $4308\text{mm} \times 2225\text{mmH}$